

100KSPS 16-bit Analog I/O Board for PCI Express

AIO-161601E3-PE



* Specifications, color and design of the products are subject to change without notice.

This product is an unisolated PCI Express bus-compliant interface board that expands the I/O function of a PC for analog signals.

This product carries high-capacity buffer memory for 16M data for analog input, allowing background sampling to be performed in a variety of trigger conditions.

This product also has one analog output channel, four channels for TTL level digital input, and four channels for TTL level digital output.

The resolution and conversion speed of analog input block is 16-bit and 10 μ sec/ch. Using specially designed accessories allows you to expand functions such as additional channels, simultaneous sampling and isolation amplifier. It is bundled with full-fledged software "C-LOGGER".

The product can also be used as a data recording device for MATLAB and LabVIEW, using dedicated libraries as plug-ins.

Features

Resolution :16-bit, combination speed : 10 μ sec/ch

The product has is the high-precision type that performs A-D conversion at a conversion speed of 10 μ sec/ch and a resolution of 16-bit.

The product has analog input 16ch, analog output 1ch, digital input/output (TTL level: four each), and a counter (32-bit, TTL level 1ch). In addition, the analog input can be set to single-end input 16ch or differential input 8ch, while the counter is commonly used as the digital input/output.

Equipped with mass-storage buffer memory (16M data) that can be used in the FIFO or RING format

The analog input block contains mass-storage buffer memory (16M data) that can be used in the FIFO or RING format. This allows for background analog input that does not depend on the operation status of the software or PC.

A variety of accessories are available for function expansion.

A number of accessories are available to expand the functions even further: a buffer amplifier, simultaneous sampling, isolation and current/thermocouple input, a low-pass filter, additional channels (+ 16ch), cables, etc.

Bundled with data logger software and Windows/Linux driver libraries

Using the bundled data logger software "C-LOGGER" allows you to display recorded signal data in graphs, perform zoom measurement, save files, and perform dynamic transfer of data to the spreadsheet software "Excel" without any special program. In addition, the product is bundled with the driver library API-PAC(W32) which can be used to create various Windows/Linux applications as well as a diagnostic program which can be used to check the hardware operation.

The start/end of sampling can be controlled by software, comparison of conversion data, an external trigger, etc.

You can select from software, comparison of conversion data or an external trigger (timing of an externally input control signal) to control the start of sampling.

you can select from completion of sampling for a specified number of sessions, comparison of conversion data, an external trigger or software to control the end of sampling. The sampling cycle can be selected from the internal clock (high-precision timer mounted on the board) or an external clock (externally input control signal).

Supporting MATLAB and LabVIEW using dedicated libraries as plug-ins

Using dedicated libraries allows you to create various MATLAB and LabVIEW applications.

Software-based calibration function

Calibration of analog input/output can be all performed by software. Apart from the adjustment information prepared before shipment, additional adjustment information can be stored according to the use environment.

Specification

Item	Specification
Analog input	
Isolated specification	Un-Isolated
Type	Single-Ended Input or Differential Input (Jumper setup)
Number of input channels	16ch (Single-Ended Input) 8ch (Differential Input)
Input range	Bipolar $\pm 10V$, $\pm 5V$ or Unipolar 0 - +10V, 0 - +5V (Jumper setup)
Absolute max. input voltage	$\pm 20V$
Input impedance	1M Ω or more
Resolution	16-bit
Non-Linearity error *1*2*3	$\pm 5LSB$
Conversion speed	10 μ sec/ch (Max.)
Buffer memory	16M data FIFO or 16M data RING (Software setup)
Conversion start trigger	Software/Input data comparison/TTL level external signal
Conversion stop trigger	Specified sampling data stored /Input data comparison/ TTL level external signal/Software
Analog output	
Isolated specification	Un-Isolated
Number of output channel	1ch
Output range	Bipolar $\pm 10V$ / Unipolar 0 - +10V (Jumper setup)
Output current ability	$\pm 5mA$
Output impedance	1 Ω or less
Resolution	16-bit
Non- Linearity error *1	$\pm 3LSB$
Conversion speed	10 μ sec/ch (Max.)
Digital I/O	
Number of output channels	Un-Isolated input 4ch (TTL, Selection of a counter output is possible at a jumper.)
Number of input channels	Un-Isolated output 4ch (TTL, A counter control input and common use are possible at a jumper.)
Counter	
Counter device	i8254 equivalent
Counter clock	Internal (4MHz) or External signal
I/O address	Any 32-byte boundary
Interrupt	1 level use
Power consumption *4	+3.3V 1500 mA (Max.)
Operating condition	0 - 50°C, 10 - 90%RH (No condensation)
Bus specification	PCI Express Base Specification Rev. 1.0a x1
Physical dimensions (mm)	169.33(L) x 110.18(H)
Interface connectors	
CN1	37 pin D-SUB connector [F (female) type] Screw lock #4-40UNC DCLC-J37SAF-20L9E [mfd. by JAE] equivalent to it
CN2	16-pin Pin-header PS-16SEN-D4P1-1C [mfd. by JAE] equivalent to it
Weight	160g

*1 When the environment temperature is near 0°C or 50°C, the non-linearity error may become larger.

*2 At the time of the source use of a signal which built in the high-speed operational amplifier.

*3 An error of about 0.02% of the maximum range value may occur with an un-isolated bipolar setting of $\pm 5V$ or an un-isolated unipolar setting of 0 - +5V.

*4 If it is supplied +5VDC from the CN1 or CN2 connectors to the external device, the power consumption of this board will be bigger than what this specification has defined.

Board Dimensions

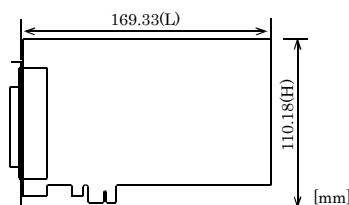

The standard outside dimension (L) is the distance from the end of the board to the outer surface of the slot cover.

Support Software

Windows version of analog I/O driver

API-AIO(WDM)/API-AIO(98/PC)

[Stored on the bundled CD-ROM driver library API-PAC(W32)]

The API-AIO(WDM)/API-AIO(98/PC) is the Windows version driver library software that provides products in the form of Win32 API functions (DLL). Various sample programs such as Visual Basic and Visual C++, etc and diagnostic program useful for checking operation is provided.

< Operating environment >

OS Windows Vista, XP, Server 2003, 2000
Adaptation language Visual Basic, Visual C++, Visual C#,
Delphi, C++ Builder

You can download the updated version from the CONTEC's Web site (<http://www.contec.com/apipac/>). For more details on the supported OS, applicable language and new information, please visit the CONTEC's Web site.

Linux version of analog I/O driver API-AIO(LNX)

[Stored on the bundled CD-ROM driver library API-PAC(W32)]

The API-AIO(LNX) is the Linux version driver software which provides device drivers (modules) by shared library and kernel version. Various sample programs of gcc are provided.

< Operating environment >

OS RedHatLinux, TurboLinux
(For details on supported distributions, refer to Help available after installation.)

Adaptation language gcc

You can download the updated version from the CONTEC's Web site (<http://www.contec.com/apipac/>). For more details on the supported OS, applicable language and new information, please visit the CONTEC's Web site.

Data Logger Software C-LOGGER

[Stored on the bundled CD-ROM driver library API-PAC(W32)]

C-LOGGER is a data logger software program compatible with our analog I/O products. This program enables the graph display of recorded signal data, zoom observation, file saving, and dynamic transfer to the spreadsheet software "Excel". No troublesome programming is required.

CONTEC provides download services (at <http://www.contec.com/clogger/>) to supply the updated drivers. For details, refer to the C-LOGGER Users Guide or our website.

< Operating environment >

OS Windows Vista, XP, Server 2003, 2000

Data acquisition VI library for LabVIEW VI-DAQ (Available for downloading (free of charge) from the CONTEC web site.)

This is a VI library to use in National Instruments LabVIEW. VI-DAQ is created with a function form similar to that of LabVIEW's Data Acquisition VI, allowing you to use various devices without complicated settings.

See <http://www.contec.com/vidaq/> for details and download of VI-DAQ.

Data Acquisition library for MATLAB ML-DAQ (Available for downloading (free of charge) from the CONTEC web site.)

This is the library software which allows you to use our analog I/O device products on MATLAB by the MathWorks. Each function is offered in accordance with the interface which is integrated in MATLAB's Data Acquisition Toolbox.

See <http://www.contec.com/mldaq/> for details and download of ML-DAQ.

Cable & Connector

< For analog I/O >

Flat Cable with One 37-pin D-Type Connector
: PCA37P-1.5 (1.5m)

Shielded Cable with One 37-pin D-Type Connector
: PCA37PS-0.5P (0.5m)
: PCA37PS-1.5P (1.5m)

Shielded Cable with Two 37-pin D-Type Connectors
: PCB37PS-0.5P (0.5m)
: PCB37PS-1.5P (1.5m)

Flat Cable with Two 37-pin D- SUB Connectors
: PCB37P-1.5 (1.5m)

Coaxial Cable for Single-ended Inputs
: PCC16PS-1.5 (1.5m)
: PCC16PS-3 (3m)

2 Wires Shielded Cable for Differential Inputs
: PCD8PS-1.5 (1.5m)
: PCD8PS-3 (3m)

< For digital I/O >

Flat Cable with One 15-pin D-Type Connector
: PCA15P-1.5 (1.5m)

Flat Cable with Two 15-pin D-Type Connectors
: PCB15P-1.5 (1.5m) *1*2

Flat Cable with 1 Sided 16-Pin
Header Connector (1.5m) : DT/E1

Conversion Cable (16-Pin to 15-Pin)
with Bracket (100mm) : DT/E2

Conversion Cable (16-Pin to 15-Pin)
with Bracket (150mm) : DT-E3

< Connector >

D-SUB37P Male Connector Set (5pieces)
: CN5-D37M

*1 DT/E2 required
*2 For FTP-15 only

Accessories

Accessories (Option)

Termination panel with Screw Terminals for Spade Lugs
: DTP-3A *3
Termination panel with Screw Terminals : DTP-4A *3
Termination panel with BNC connectors for Analog
Multi-function Boards : ATP-16E *3
Buffer amplifier termination panel for analog multi-function box
: ATBA-16E *3
Termination panel for Digital I/O on Analog Multi-function
Boards : FTP-15 *4
Screw Terminal : EPD-37A *3*5
Screw Terminal : EPD-37 *3
16 Channel Simultaneous Sample & Hold Accessory
: ATSS-16A *3*6
8ch-Isolation Accessory Board for Analog Inputs : ATII-8C *3
8ch Gain Operation Amplifier Accessory Board
for Analog Input : ATLF-8A *3
16CH Multiplexer Sub-Board for AIO-121601E3-PE and
AIO-161601E3-PE : ATCH-16A(PCI)

*3 A PCB37PS -*P optional cable is required separately. (0.5m is recommended.)

*4 A DT/E2 and PCB15P-1.5 optional cable is required separately.

*5 " Screw upright terminal panel" is used to prevent terminal screws from falling off.

*6 A separate external power supply is required.

* Check the CONTEC's Web site for more information on these options.

Packing List

Board [AIO-161601E3-PE] ... 1
First step guide ... 1
CD-ROM *1 [API-PAC(W32)] ... 1

*1 The CD-ROM contains the driver software and User's Guide.

How to connect the connectors

Connector shape

To connect an external device to this board, plug the cable from the device into the interface connector (CN1, CN2) shown below. The board has two interface connectors: the analog I/O connector (CN1: 37-pin female D-SUB connector) and the control signal connector (CN2: 16-pin pin-header) for digital input/output and counter control.

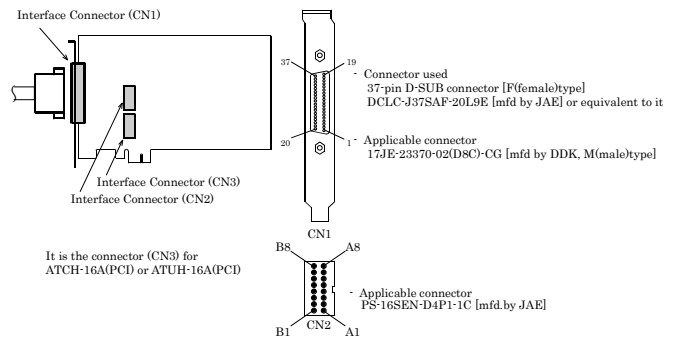

* Please refer to page 3 for more information on the supported cable and accessories.

Examples of Connecting Options

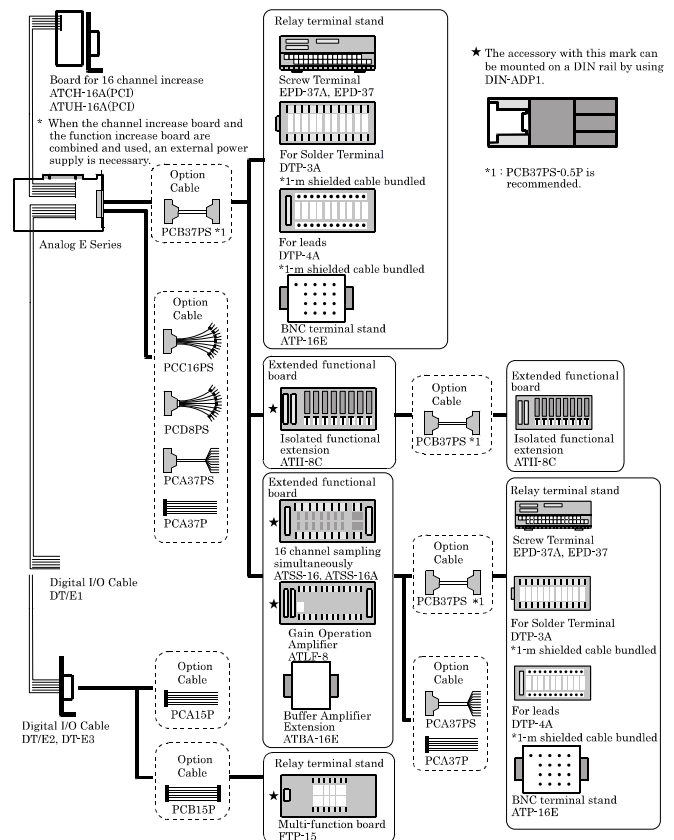

- Connector Pin Assignment

Pin Assignment of CN1

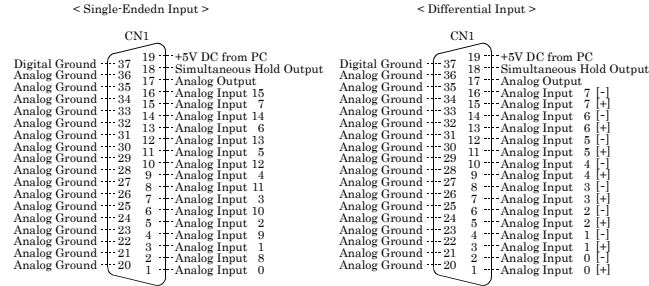

Analog Input 0 - Analog Input 15	Analog input signals in single-ended input mode. The numbers correspond to channel numbers.
Analog Input 0[+] - Analog Input 7[+]	Analog input signals in differential input mode. The numbers correspond to channel numbers.
Analog Input 0[-] - Analog Input 7[-]	Analog input signals in differential input mode. The numbers correspond to channel numbers.
Analog Output	Analog output signal
Analog Ground	Analog ground common to analog I/O signals.
Simultaneous Hold Output	Control signal for simultaneous sampling unit ATSS-16 available as an option.
+5V DC from PC	Outputs +5V. The total current-carrying capacity that can be supplied with 5V output of CN2 is 0.9A.
Digital Ground	Digital ground common to "Simultaneous Hold Output" and "+5V DC from PC".

⚠ CAUTION

Do not connect any of the outputs and power outputs to the analog or digital ground.
Neither connect outputs to each other. Doing either can result in a fault.

Pin Assignment of CN2

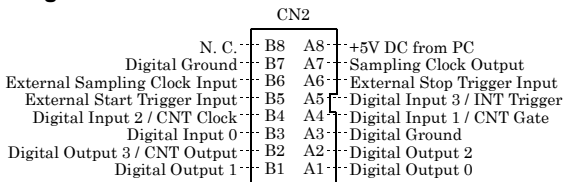

Digital Input 0	Digital input signal.
Digital Input 1 /CNT Gate	Digital input signal. Also serving as the counter gate control input signal.
Digital Input 2 /CNT Clock	Digital input signal. Also serving as the clock input signal
Digital Input 3 /INT Trigger	Digital input signal. Also serving as the interrupt input signal.
Digital Out 0 to Digital Out 2	Digital output signal.
Digital Out 3 to CNT Output	Digital output signal. Capable of being jumper-switched to serve as the counter output signal.
External Start Trigger Input	External trigger input signal for sampling start conditions
External Stop Trigger Input	External trigger input signal for sampling stop conditions
External Sampling Clock Input	External sampling clock input signal
Sampling Clock Output	Sampling clock output signal
+5V DC from PC	Outputs +5V. The total current-carrying capacity that can be supplied with 5V output of CN1 is 0.9A.
Digital Ground	Digital ground common to the signals and "+5V DC from PC".
N.C.	No connection to this pin.

⚠ CAUTION

Do not connect any of the outputs and power outputs to the analog or digital ground.
Neither connect outputs to each other. Doing either can result in a fault.

Analog Input Signal Connection

There are two analog input mode: the Single-ended input and the Differential input. Here we give some examples of analog input connections by using flat cable or shield cable.

Single-ended Input

The following figure shows an example of flat cable connection. Each signal source is connected to one analog input channel and the signal common to analog ground pin of CN1.

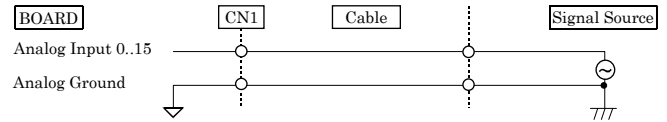

The following figure shows an example of shield cable connection. When the distance between the signal source and the board is long or you want to increase the noise tolerance, a shield cable is suggested. Connect the signal by the core wire and common signal by the shield braids.

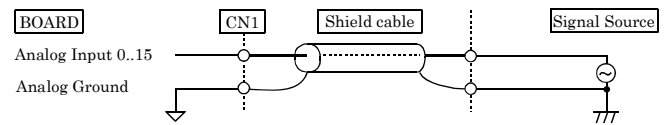

⚠ CAUTION

If the signal source contains over 100kHz signals, the signal may effect the cross-talk noise between channels.
If the board and the signal source receive noise or the distance between the board and the signal source is too long, data may not be input properly.

An input analog signal should not exceed the maximum input voltage (relate to the board analog ground). If it exceeds the maximum voltage, the board may be damaged.

Connect all the unused analog input channels to analog ground.

Differential Input

The following figure shows an example of flat cable connection. Each signal source is connected to a [+] pin of analog input channel and the signal common of this source to the [-] pin of this input channel of CN1. In addition, the signal common must be connected to the pin of the analog ground of CN1 by a third wire.

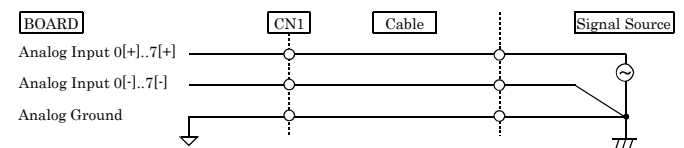

The following figure shows an example of 2-wire shielded cable connection. When the distance between the signal source and the board is long or you want to increase the noise tolerance, a shield cable connection is preferred. Each signal source is connected to a [+] pin of analog input channel and the signal common of this source to the [-] pin of this input channel of CN1. In addition, the signal common must be connected to the pin of the analog ground of CN1 by the shielded braids.

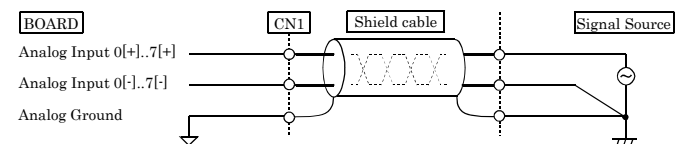

CAUTION

If the signal source contains over 100kHz signals, the signal may effect the cross-talk noise between channels. The input data would be uncertain if the analog ground is not connected.

If the board and the signal source receive noise or the distance between the board and the signal source is too long, data may not be input properly.

The input voltage from the [+] input or [-] input should not exceed the maximum input voltage (based on the board analog ground). If it exceeds the maximum voltage, the board may be damaged.

Because the input data will be uncertain if the [+] pin or the [-] pin of CN1 is not connected, all the unused input pins of CN1 should be connected to the analog ground, AGND.

Analog Output Signal Connection

This section shows how to connect the analog output signal by using a flat cable or a shielded cable. The following figure shows an example of flat cable connection. Connect the signal source and ground to the CN1 analog output.

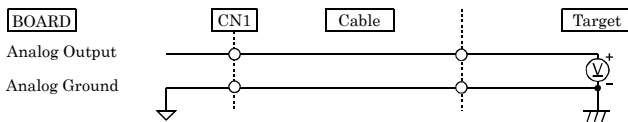

If the distance between the signal source and the board is long or if you want to increase the noise tolerance, a shield cable connection is strongly recommended.

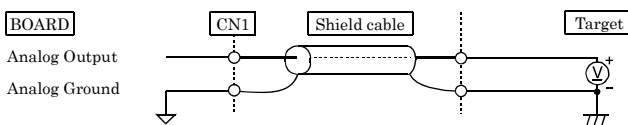

CAUTION

If the board or the connected wire receives noise, or the distance between the board and the target is long, data may not be outputted properly.

For analog output signal, the current capacity is $\pm 5\text{mA}$ (Max.). Check the specification of the connected device before connecting the board.

Do not short the analog output signal to analog ground, digital ground, and/or power line. Doing so may damage the board.

Digital I/O signals and Control signals Connection

The digital I/O signals and the control signals are interfaced through the connector CN2. User can use an optional cable DT/E1 or DT/E2 or DT-E3 (with bracket and a 15-pin D type female connector) to connect these signals to your external devices.

All the digital I/O signals and control signals are TTL level signals.

Digital Input Connection

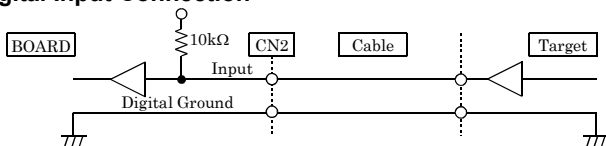

Digital Output Connection

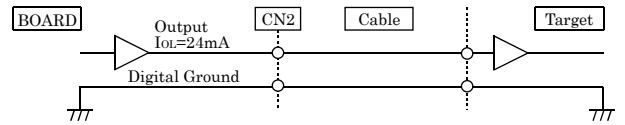

CAUTION

Do not short the output signals to analog ground, digital ground, and/or power line. Doing so may damage the board.

Block Diagram

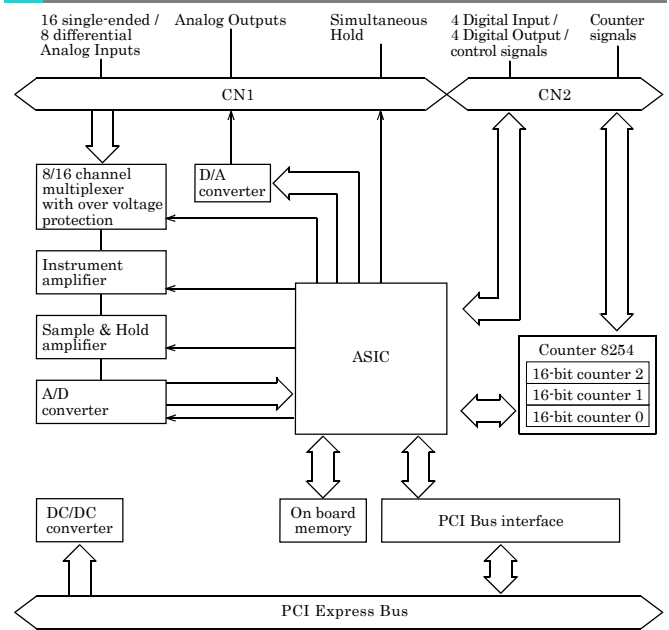

Differences between past analog E and this product

Based on the previous analog E series for the PCI bus, this product has been redesigned to support the PCI Express bus. Therefore, the same usage as the E series for PCI bus can be basically done.

There are some differences in specifications as shown below.

Past E Series : AD16-16(PCI)EV, AD16-16(PCI)E

This product : AIO161601E3-PE

	AIO161601E3-PE	AD16-16(PCI)EV	AD16-16(PCI)E
I/O address	Any 32-byte boundary		Any 16-byte boundary
Analog input range	Jumper setting (The setting different from old goods)		Jumper setting
Analog output range	Jumper setting (The setting different from old goods)		Jumper setting
Buffer memory	16M data FIFO or 16M data RING *1		256K data FIFO or 256K data RING
Analog output Non- Linearity error	$\pm 3\text{LSB}$		$\pm 2\text{LSB}$
Power consumption	+3.3V 1500mA (Max.)	+5V 1000mA (Max.)	+5V 1100mA (Max.)
External supply capable current	+5V DC from PC CN1 0.9A CN2 0.9A (CN1 + CN2)	+5V DC from PC CN1 2A CN2 1A	
Interrupt signal resource setting	Automatically set by PC		Set to select whether to use jumper JP12
Bus specification	PCI Express Base Specification Rev. 1.0a x1	PCI (32-bit, 33MHz, Universal key shapes supported)	PCI(32-bit, 33MHz, 5V key shapes supported)
Physical dimensions (mm)	169.33(L) x 110.18(H)	176.41(L) x 105.68(H)	176.41(L) x 106.68(H)

*1 It is necessary to correct the application because the capacity of the buffer memory is different when replacing it from old goods.