

NuDAQ[®]

ACLD Series

Termination Boards

User's Guide

©Copyright 1995~2000 ADLINK Technology Inc.
All Rights Reserved.

Part No. 50-14006-200
Manual Rev. 2.40: June 7, 2000

The information in this document is subject to change without prior notice in order to improve reliability, design and function and does not represent a commitment on the part of the manufacturer.

In no event will the manufacturer be liable for direct, indirect, special, incidental, or consequential damages arising out of the use or inability to use the product or documentation, even if advised of the possibility of such damages.

This document contains proprietary information protected by copyright. All rights are reserved. No part of this manual may be reproduced by any mechanical, electronic, or other means in any form without prior written permission of the manufacturer.

Trademarks

NuDAQ is a registered trademark of ADLink Technology Inc.

Other product names mentioned herein are used for identification purposes only and may be trademarks and/or registered trademarks of their respective companies.

Getting service from ADLINK

Customer Satisfaction is always the most important thing for ADLINK Tech Inc. If you need any help or service, please contact us and get it.

ADLINK Technology Inc.			
Web Site	http://www.adlink.com.tw		
Sales & Service	service@adlink.com.tw		
Technical Support	NuDAQ	nudaq@adlink.com.tw	
	NuDAM	nudam@adlink.com.tw	
	NuIPC	nuipc@adlink.com.tw	
	NuPRO	nupro@adlink.com.tw	
	Software	sw@adlink.com.tw	
	AMB	amb@adlink.com.tw	
TEL	+886-2-82265877	FAX	+886-2-82265717
Address	9F, No. 166, Jian Yi Road, Chungho City, Taipei, 235 Taiwan, R.O.C.		

Please inform or FAX us of your detailed information for a prompt, satisfactory and constant service.

Detailed Company Information			
Company/Organization			
Contact Person			
E-mail Address			
Address			
Country			
TEL		FAX	
Web Site			
Questions			
Product Model			
Environment to Use	<input type="checkbox"/> OS _____ <input type="checkbox"/> Computer Brand _____ <input type="checkbox"/> M/B : <input type="checkbox"/> CPU : <input type="checkbox"/> Chipset : <input type="checkbox"/> Bios : <input type="checkbox"/> Video Card : <input type="checkbox"/> Network Interface Card : <input type="checkbox"/> Other :		
Challenge Description			
Suggestions for ADLink			

Contents

Chapter 1

ACLD-9185	1
1.1 Introduction	1
1.1.1 Features	1
1.1.2 Specifications	2
1.2 Installation	2
1.2.1 What you have	2
1.2.2 ACLD-9185 Layout	3
1.2.3 Power Source Setting	4
1.2.4 Connect to add-on card	5
1.3 Usage	5
1.4 Connector Pin Assignments	6
1.5 Applications	6

ACLD-9182A	7
2.1 Introduction	7
2.1.1 Features	7
2.1.2 Specifications	8
2.2 Installation	8
2.2.1 What you have	8
2.2.2 ACLD-9182A's Layout	9
2.2.3 Connect to add-on card	9
2.3 Usage	10
2.3.1 Input Mode Setting	10
2.3.2 Adjust Threshold for Isolated Mode	11
2.3.3 Customize the Current Limit Resistor	11

2.4	Connector Pin Assignments.....	12
2.5	Applications	13
ACLD-8125	14
3.1	Introduction	14
3.2	Installation.....	14
3.2.1	<i>What you have</i>	15
3.2.2	<i>ACLD-8125 Layout</i>	15
3.2.3	<i>Connect to add-on card</i>	16
3.3	How to use ACLD-8125	16
3.3.1	<i>ACL-8125 Connections</i>	16
3.3.2	<i>CJC Output Configurations</i>	17
3.3.3	<i>Circuit Diagram of ACLD-8125</i>	18
3.4	Connector Pin Assignments.....	19
3.5	Exapmle for temperature measuring by using the ACL-8112 and ACLD-8125	20
3.6	Applications	21
ACLD-9178	22
4.1	Introduction	22
4.1.1	<i>Features</i>	22
4.2	Installation.....	22
4.2.1	<i>What you have</i>	23
4.2.2	<i>ACLD-9178 Layout</i>	23
4.3	Signal Conditioning Circuits	24
4.4	Pin Assignment.....	25

4.5 Applications	26
ACLD-9188	27
5.1 Introduction	27
5.1.1 Features	27
5.2 Installation.....	28
5.2.1 What you have	28
5.2.2 ACLD-9188 Layout.....	28
5.3 Signal Conditioning Circuits	29
5.4 Pin Assignment.....	29
5.5 Applications	30
ACLD-9138	31
6.1 Introduction	31
6.2 Installation.....	31
6.2.1 What you have	31
6.2.2 ACLD-9138 Layout.....	32
6.3 Using the ACLD-9138	33
6.3.1 Signal Conditioning Circuits	33
6.3.2 Power Indicator	33
6.4 Applications	34
6.5 Pin Assignment.....	34
ACLD-9881	35
7.1 Introduction	35
7.1.1 Features	35

7.2	Installation.....	35
7.2.1	What you have	36
7.2.2	ACLD-9881 Layout.....	36
7.3	Signal Conditioning Circuits	37
7.4	Applications	37
7.5	Pin Assignment.....	38
	Product Warranty/Service.....	39

How To Use This Guide

This manual is designed to help users to use the ADLink termination boards. The products described in this manual include:

- ACLD-9185
- ACLD-9182A
- ACLD-8125
- ACLD-9178
- ACLD-9188
- ACLD-9138
- ACLD-9881

The manual describes how to modify settings on the daughter board to meet your applications.

Termination Boards	Applications for NuDAQ
ACLD-9185	PCI-9111 Series, ACL-8312/8316, ACL-8112 Series, ACL-8216, ACL-6126, ACL-7120
ACLD-9182A	PCI-9111 Series, ACL-8312/8316, ACL-8112 Series, ACL-8216, ACL-6126, ACL-7120
ACLD-8125	PCI-9112, PCI-9111 Series, ACL-8312/8316, ACL-8112 Series, ACL-8126
ACLD-9178	ACL-8312/8316, ACL-8216, ACL-6126, ACL-7120
ACLD-9188	PCI-9114 Series, PCI-9111 Series, PCI-6208 Series, PCI-8133, PCI-7200, PCI-7230, PCI-7250/7251, ACL-8312/8316, ACL-8112 Series, ACL-8216, ACL-8111, ACL-6126, ACL-7130, ACL-9188, ACL-7225
ACLD-9138	PCI-9112, PCI-9111 Series, ACL-8312/8316, ACL-8112 Series, ACL-8216
ACLD-9881	PCI-9113A, ACL-8113A

ACLD-9185

1.1 Introduction

The ACLD-9185 is a 16-channel SPDT form C relay output board. It provides 16 electromechanical SPDT relays, which can be used by any ACL series or PCI series boards with digital output channels on 20-pin flat ribbon connector.

You can use the 16 on-board relays to control power switches. Each of them matches with one LED to indicate its ON/OFF status and consumes about 33mA when energized. When all relays on the board are active, the board takes about 0.53 A from the computer's 12 volts power supply. When the current driving capability of the 12V power source is not enough, the ACLD-9185 has a jumper switch allowing the users to connect an external +12V power source.

1.1.1 Features

The ACLD-9185 Relay Actuator Card provides the following features:

- 16 Single-Pole-Double-Throw relays
- LED indicators to show activated relays
- On-board relay driving circuits
- 120V/1 Amp contact rating
- Simple to program
- Controlled through TTL/CMOS signals or digital output ports of any ACL and PCI series board

- Screw terminal for easily wiring

1.1.2 Specifications

Output Channels	16
Relay Type	16 SPDT (Form C)
Contact rating	120V AC/DC, 1A
Breakdown Voltage	1000V AC/DC min..
Release time	5 msec max.
Operate time	5 msec max..
Relay ON time	3 msec typical
Relay OFF time	3 msec typical
Total switching time	10 msec typical
Insulation Resistance	100 mega Ohms min.
Life Expectancy	> 5 million operations at full load
Power Consumption	+12V , 33mA for each relay, total 0.53A if all relay are energized +5V, less than 0.2A
Power supply	+12V from the PC-Bus
Size	203 mm X 132mm
Connectors	20-pin flat cable

1.2 Installation

To install and operate the ACLD-9185, you can follow the following steps:

- Check what you have in the box
- Check the PCB
- Set jumper (set power source)
- Make connection to add-on cards
- Program the add-on cards

1.2.1 What you have

In addition to this *User's Manual*, the package includes the following items:

- ACLD-9185 Relay Output Board
- Cable
- Nylon standoffs for table-top or panel mounting

If any of these items was missed or damaged, contact the dealer whom you purchased. Save the shipping materials and carton in case you want to ship or store the product in the future.

1.2.2 ACLD-9185 Layout

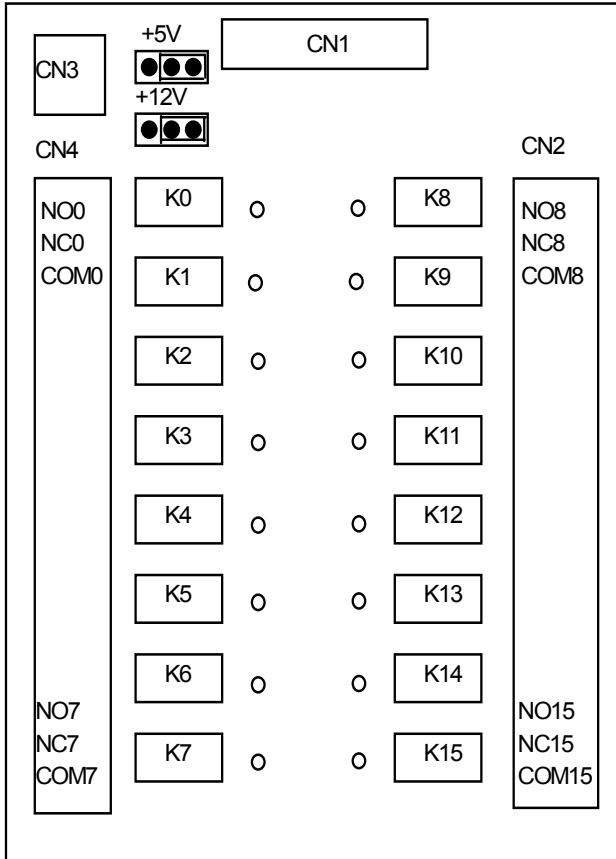









1.2.3 Power Source Setting

The ACLD-9185's power source can come from internal source (provided from the PC bus via the CN1 20-pin connector) or external source (provided by external power supply). The +5V is used to drive the TTL buffer circuits and the LED on board. The +12V is used to drive the Relays. The description of power source is specified as following table:

Internal power	+12V +5V	Provided by PC bus via the CN1 20-pin connector
External power	+12V +5V	Provided by external DC source via connector CN3

The power sources can be selected by setting jumpers according to the following table.

Internal +5V Internal +12V (default)	 +5V  +12V
External +5V External +12V	 +5V  +12V
Internal +5V External +12V	 +5V  +12V
External +5V Internal +12V	 +5V  +12V

1.2.4 Connect to add-on card

The ACLD-9185 can be controlled with NuDAQ ISA or PCI add-on cards. The configurations of connection are shown in the following diagram. Please make sure to connect to the digital output port of the add-on cards with correct pin-assignment.

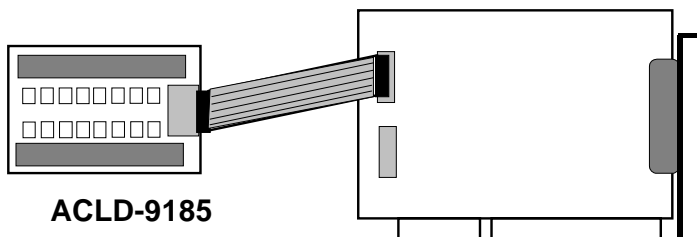

1.3 Usage

The function diagram of Form C relays on the ACLD-9185 is shown here.

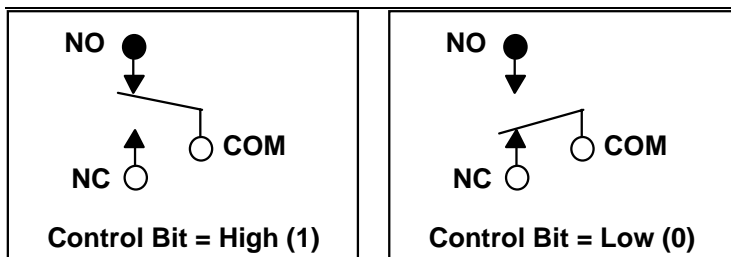

This relay has three contacts: NC (Normal Closed), NO (Normal Open), and COM (Common). The COM post, located at the middle, can make contact either NO post or NC post. When the control bit is high (1), the COM post and NO post are contacted. If the control bit is low (0), the COM post and NC post make contact.

In normal power-up and reset, the relay is in **low** status.

1.4 Connector Pin Assignments

The relationship between connector pins, relay contacts, LED's, and on the ACLD-9185 is shown in the following table:

CN1 PIN	RELAY	RELAY Contacts	LED
1	K0	COM0 NC0 NO0	0
2	K1	COM1 NC1 NO1	1
3	K2	COM2 NC2 NO2	2
4	K3	COM3 NC3 NO3	3
5	K4	COM4 NC4 NO4	4
6	K5	COM5 NC5 NO5	5
7	K6	COM6 NC6 NO6	6
8	K7	COM7 NC7 NO7	7
9	K8	COM8 NC8 NO8	8
10	K9	COM9 NC9 NO9	9
11	K10	COM10 NC10 NO10	10
12	K11	COM11 NC11 NO11	11
13	K12	COM12 NC12 NO12	12
14	K13	COM13 NC13 NO13	13
15	K14	COM14 NC14 NO14	14
16	K15	COM15 NC15 NO15	15
17	Ground		
18	Ground		
19	+5 DC		
20	+12 DC		

1.5 Applications

The ACLD-9185 could be used on our following products:

- ✓ PCI-9111Series
- ✓ PCI-9112
- ✓ ACL-8312/8316
- ✓ ACL-8112 Series
- ✓ ACL-8216
- ✓ ACL-6126, ACL-7120

2

ACLD-9182A

This chapter describes how to install and use the ACLD-9182A.

2.1 Introduction

The ACLD-9182A is a 16-channel opto-isolated digital input board, which can be connected by any ACL or PCI series digital input board with D/I channels of 20-pin flat ribbon connectors. It is a good solution for preventing floating potential and ground loop problems.

Each input channel has a red LED to indicate the ON/OFF status. If the input voltage is high, the LED will be on otherwise the LED is off. AC or DC input is selectable by setting the jumpers. And you do not need to care the polarity.

2.1.1 Features

- 16 Opto-Isolated digital input channels
- For use with 20-pin digital input connector of NuDAQ cards
- AC or DC polarity-free digital input
- Screw terminals for easy wiring
- On board LEDs to indicate the input logic status

2.1.2 Specifications

Number of channel	16
Opto-coupler	4N35
Input impedance	1.2K ohm
Threshold voltage	1.5 VDC
Isolation voltage	1000 VDC(channel to channel and channel to ground)
Input mode	Isolation and dry contact input range
Response time	20uSec without AC filter
Connector	20-Pin Flat Ribbon Cable Connector
Screw Terminal	5mm wiring spacing, 18-22 AWG
Indication Display	16 LEDs
Size	205 mm X 114 mm

2.2 Installation

To install and operate the ACLD-9182A, please follow the following steps:

- Check what you have in the box
- Check the PCB
- Make connection to add-on cards
- Program the add-on cards

2.2.1 What you have

In addition to this *User's Manual*, the package includes the following items:

- ACLD-9182A Photo coupler input Board
- Cable
- Nylon standoffs for table-top or panel mounting

If any of these items was missed or damaged, contact the dealer whom you purchased. Save the shipping materials and carton in case you want to ship or store the product in the future.

2.2.2 ACLD-9182A's Layout

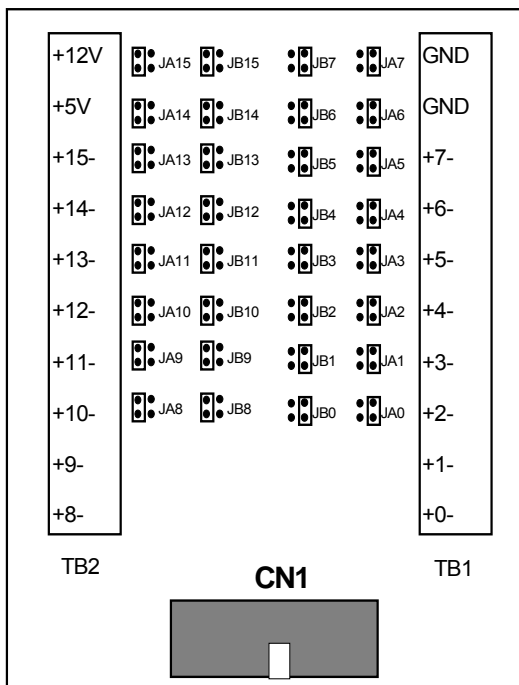

2.2.3 Connect to add-on card

The ACLD-9182A can be controlled with NuDAQ ISA or PCI add-on cards. The configurations of connection are shown in the following diagram. Please make sure to connect to the digital output port of the add-on cards with correct pin-assignment.

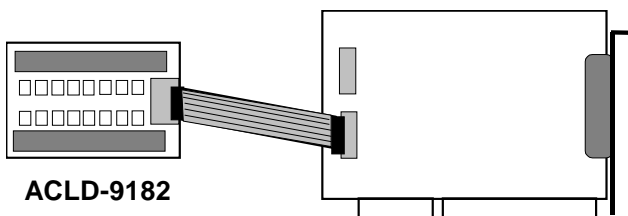

2.3 Usage





By setting the JAn and JBn jumpers, you can choose the isolated or dry input(see the 2.3.1). And adjust threshold for isolated mode by tuning VR1(see 2.3.2).

2.3.1 Input Mode Setting





There are 2 jumpers (JAn and JBn, $n = 0 \sim 15$) associated with each digital input channel for configuring the channel as isolated or non-isolated (Dry Contact) input. The digital input channels and their corresponding jumper is shown below.

Each channel comes equipped with a pair of jumpers for either isolated or non-isolated selection. If the jumper plugs are installed on the upper posts of JAn, and JBn ($n = 0..15$), the channel n is configured as ISOLATED, otherwise the jumper plugs should be installed on the lower posts to configure as Non-isolated.

For channel 0~7 ($n=0..7$)

Input Signal Selection	Isolated	Non-isolated
JAn		
JBn		

For channel 8~15 ($n=8..15$)

Input Signal Selection	Isolated	Non-isolated
JAn		
JBn		

2.3.2 Adjust Threshold for Isolated Mode

The input isolated mode of the ACLD-9182A is actually driven by current instead of voltage level. The logic low means the input leakage current should be less than 1mA, otherwise the input status will be treated as logic High (1).

To avoid the logic high voltage as low, the ACLD-9182A is equipped with a variable resistor VR1, which is used to adjust the threshold level for all the 16 isolated input channels.

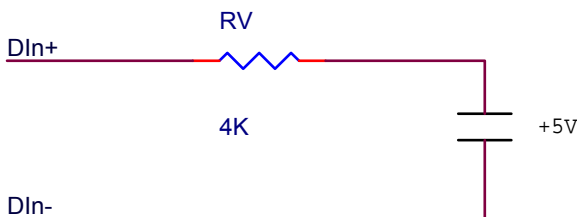

Adjusting procedures:

- 1 Apply a +5V voltage source at DIH and DIL along with a 4K Ohms resistor. The resistor limits input current to about 1mA.
- 2 Adjust the VR1 until the LED0 is off.

Follow the adjusting procedures, if channel 0's input voltage is low, and the input leakage current is less than 1mA, the input status is considered as logical low (TTL 0). To prevent higher input leakage current, you can change the 3.9K Ohms resistor by a lower one, and use the above procedures to meet your requirements.

2.3.3 Customize the Current Limit Resistor

The default voltage input range of the ACLD-9182A is from 0V to 24V. To accept higher voltage input, you should replace the current limit resistor, RA0...RA15, for each channel.

The current rating of the 4N35 photocoupler is about 60mA. It is recommended that the input current is within 20mA. If you want to choose the proper current limit resistor, please use the following formula to calculate the input current(IF).

$$\begin{aligned} V_{in} &= I_F \times R_i \\ P_w &= V_{in} \times I_F \end{aligned}$$

Where

V_{in} : Input voltage
I_F: Input current
P_w : Power rating
R_i : Current Limit resistor

For example:

If the input voltage is 40V, then the maximum input current is within 20mA, using the above formula :

$$R_i = 40 \text{ (V)} / 20 \text{ (mA)} = \mathbf{2 \text{ K}\Omega}$$
$$P_w = 40 \text{ (V)} \times 20 \text{ (mA)} = \mathbf{0.8 \text{ W}}$$

You should choose a 2K Ω resistor and the power rating of this resistor should be 1 Watt.

2.4 Connector Pin Assignments

The relationship between connector CN1's pins (below), terminal blocks (TB1 & TB2), LED's, and their related jumpers are shown in the following table :

CN1 PIN NO.	D/I Channel	TB1 & TB2 LABEL	LED NO.	RELATED JUMPER
1	DI 0	TB1 0+,0-	0	JA0, JB0
2	DI 1	TB1 1+,1-	1	JA1, JB1
3	DI 2	TB1 2+,2-	2	JA2, JB2
4	DI 3	TB1 3+,3-	3	JA3, JB3
5	DI 4	TB1 4+,4-	4	JA4, JB4
6	DI 5	TB1 5+,5-	5	JA5, JB5
7	DI 6	TB1 6+,6-	6	JA6, JB6
8	DI 7	TB1 7+,7-	7	JA7, JB7
9	DI 8	TB2 8+,8-	8	JA8, JB8
10	DI 9	TB2 9+,9-	9	JA9, JB9
11	DI 10	TB2 10+,10-	10	JA10, JB10
12	DI 11	TB2 11+,11-	11	JA11, JB11
13	DI 12	TB2 12+,12-	12	JA12, JB12
14	DI 13	TB2 13+,13-	13	JA13, JB13
15	DI 14	TB2 14+,14-	14	JA14, JB14
16	DI 15	TB2 15+,15-	15	JA15, JB15
17	GND			
18	GND			
19	+5V			
** 20	+12V			

** Pin-20 (+12V) depends on the output form digital input connector, such as ACL-8111, ACL-8112 are **+12V**, but it is **strobe** signal on ACL-7120.

2.5 Applications

The ACLD-9182A could be used on following products:

- ✓ PCI-9111 Series
- ✓ ACL-8312/8316
- ✓ ACL-8112 Series
- ✓ ACL-8216,
- ✓ ACL-6126
- ✓ ACL-7120.

3

ACLD-8125

This chapter describes how to install and use the ACLD-8125.

3.1 Introduction

The ACLD-8125 is a signal conditioning termination board with build-in cold junction temperature sensor. It has the following features:

- On board signal conditioning circuits for every analog input channels
- Cold junction temperature sensor
- Build-in screw terminals for wiring
- 37-pin D-sub connector

3.2 Installation

To install and operate the ACLD-8125, please follow the following steps:

- Check what you have in the box
- Check the PCB
- Make connection to add-on cards
- Program the add-on cards

3.2.1 What you have

In addition to this *User's Manual*, the package includes the following items:

- ACLD-8125 Signal Conditioning Termination Board
- Cable
- Nylon standoffs for table-top or panel mounting

If any of these items was missed or damaged, contact the dealer whom you purchased. Save the shipping materials and carton in case you want to ship or store the product in the future.

3.2.2 ACLD-8125 Layout

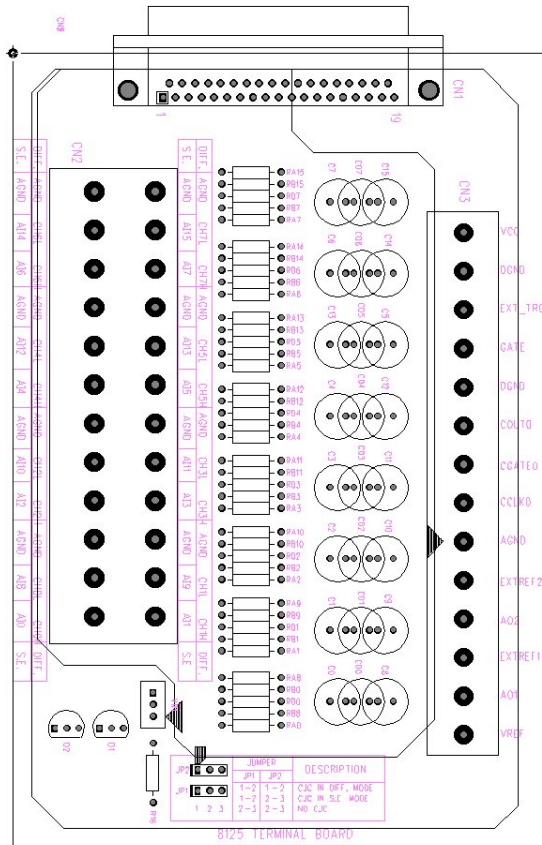

3.2.3 Connect to add-on card

The ACLD-8125 can be used with NuDAQ ISA or PCI add-on cards. The configurations of connection are shown in the following diagram. Please make sure to connect to the digital output port of the add-on cards with correct pin-assignment.

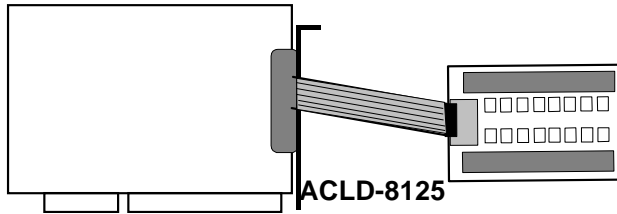

3.3 How to use ACLD-8125

3.3.1 ACL-8125 Connections

The ACL-8125 comes equipped with a DB-37 female connector; this board is designed for ACL-8112/8216/8316 and PCI-9111/9112 series cards for convenient wiring. This board provides two kinds of wiring style: single-ended and differential. The connections are illustrated as following figures.

(1) Single-ended connection

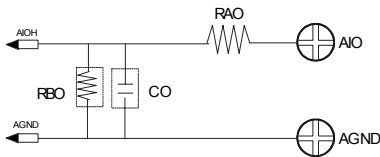

(2) Differential connection

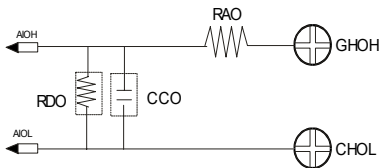

3.3.2 CJC Output Configurations

An on-board Cold Junction Compensation (CJC) circuit is provided by the ACLD-8125 for thermocouple measurement. The CJC is connected with Channel 0 of the internal connector. The circuit of CJC and CH0 is shown as following:

The jumper setting for CJC output configuration are as following:

(1) Fully Differential Single-ended with CJC

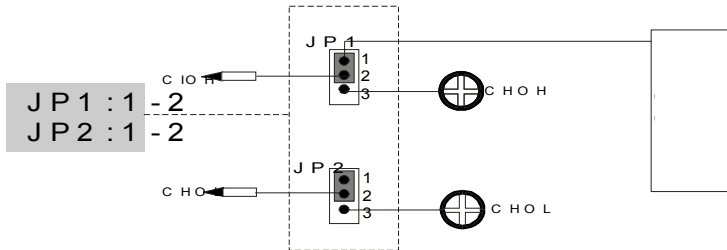

(2) Single-ended with CJC

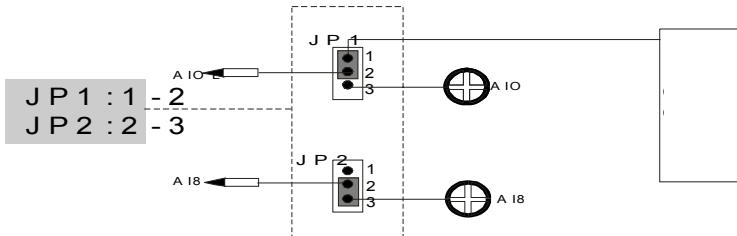

(3) Disable CJC

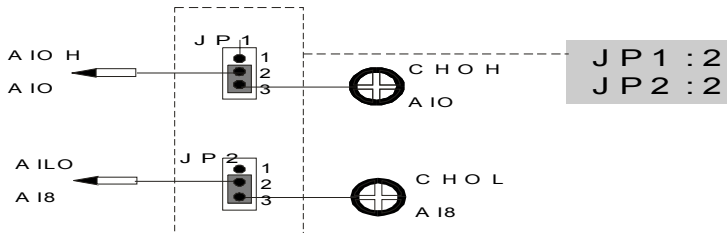

3.3.3 Circuit Diagram of ACLD-8125

(1) CJC Circuit

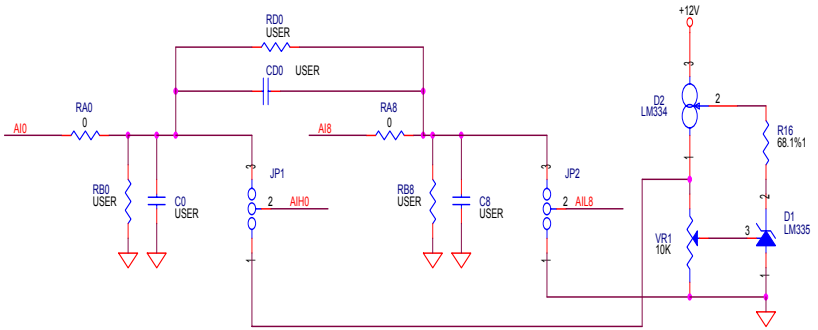

(2) Signal Conditioning Circuit

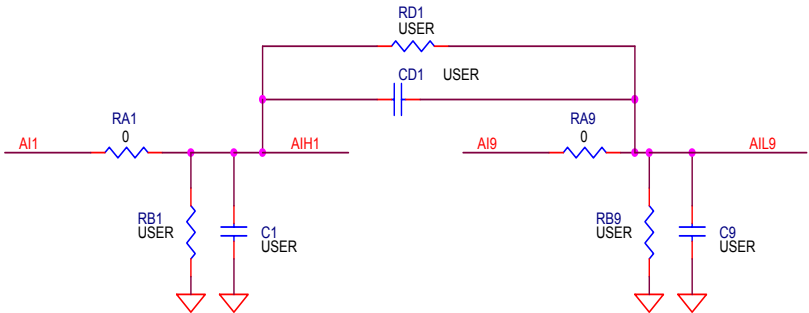

3.4 Connector Pin Assignments

Pin assignment of CN1

Pin	Description	Pin	Description
1	AIH0	20	AIL8
2	AIH1	21	AIL9
3	AIH2	22	AIL10
4	AIH3	23	AIL11
5	AIH4	24	AIL12
6	AIH5	25	AIL13
7	AIH6	26	AIL14
8	AIH7	27	AIL15
9	AGND	28	AGND
10	AGND	29	AGND
11	VREF	30	AO1
12	EXTREF2	31	EXTREF1
13	+12V	32	AO2
14	AGND	33	CNT0_GATE
15	DGND	34	GATE
16	CNT0_OUT	35	NC
17	EXT_TRG	36	NC
18	NC	37	CNT0_CLK
19	VCC		

Pin Assignment of CN2A

Pin	Description
1	AGND
2	AI14
3	AI6
4	AGND
5	AI12
6	AI4
7	AGND
8	AI10
9	AI2
10	AGND
11	AI8
12	AI0

Pin Assignment of CN2B

Pin	Description
1	AGND
2	AI15
3	AI6
4	AGND
5	AI13
6	AI5
7	AGND
8	AI11
9	AI3
10	AGND
11	AI9
12	AI1

Pin Assignment of CN3

Pin	Description
1	VREF
2	AO1
3	EXTREF1
4	AGND
5	EXTREF2
6	AGND
7	CNT0_CLK
8	CNT0_GATE
9	CNT0_OUT
10	DGND
11	GATE
12	EXT_TRG
13	DGND
14	VCC

3.5 Example for temperature measuring by using the ACL-8112 and ACLD-8125

There is an on-board CJC circuit. The CJC is connected with Channel 0 of the internal connector. It can be used for obtaining environment temperature.

- 1) ACLD-8125 JP1 : 1+2 JP2 : 2+3
- 2) ACL-8112 JP9 : +/- 5V range

3) Now you can read the CJC voltage by reading channel 0 of ACL-8112
4) If the environment temperature is 25 degree. The voltage you read is about 2.98 V

5)

$$V(\text{mV})=T('K)*10(\text{mV}/'K)$$

$$T('K)=T('C)+273('K)$$

$$2.98\text{V}=2980\text{mV}=(25+273)*10\text{mV}$$

when the JP9 on the ACL-8112 is +/-5V range.

3.6 Applications

The ACLD-8125 could be used on following products:

- ✓ PCI-9112
- ✓ PCI-9111 Series
- ✓ ACL-8312/8316
- ✓ ACL-8112 Series
- ✓ ACL-8216.

4

ACLD-9178

This chapter describes how to install and use the ACLD-8125.

4.1 Introduction

The ACLD-9178 is a universal screw terminal panel with convenient connection points for 20-pin flat cable connector.

The ACLD-9178 is designed for establishing external signal conditioning circuits. For example, you can easily construct a low-pass filter, attenuator or current-to-voltage converter by adding resistors and capacitors onto the reserved circuit pads.

4.4.1 Features

The ACLD-9178 screw terminal board provides the following features:

- Low cost universal screw terminals
- Signal conditioning circuits built-in.
- Table-top mounting using nylon standoffs
- 40 terminal points for two 20-pin flat cable connectors.
- Controlled through TTL/CMOS signals or digital output ports of any ACL series board

4.2 Installation

To install and operate the ACLD-9178, please follow the steps:

- Check what you have in the box

- Check the PCB
- Make connection to add-on cards
- Program the add-on cards

4.2.1 What you have

In addition to this *User's Manual*, the package includes the following items:

- ACLD-9178 Screw Terminal Board
- Cable
- Nylon standoffs for panel mounting.

If any of these items was missed or damaged, contact the dealer whom you purchased. Save the shipping materials and carton in case you want to ship or store the product in the future.

4.2.2 ACLD-9178 Layout

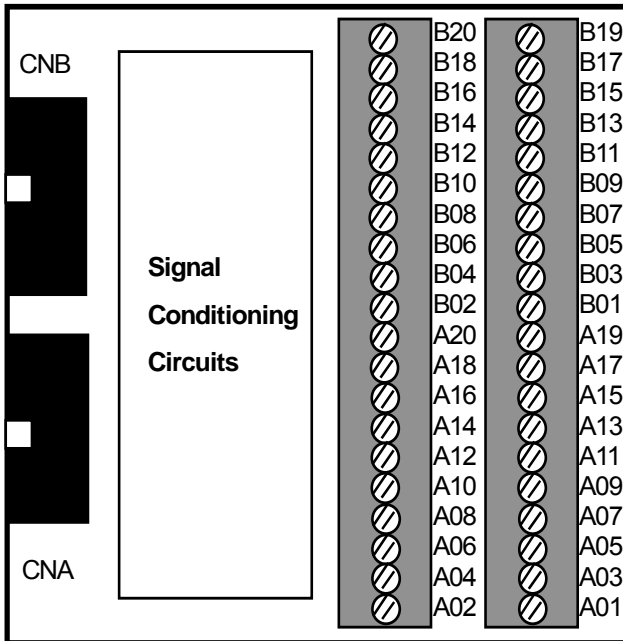

4.3 Signal Conditioning Circuits

The ACLD-9178 is suitable for specifically passive signal conditioning components. The following circuits are examples of signal conditioning for screw connector A1 and A2.

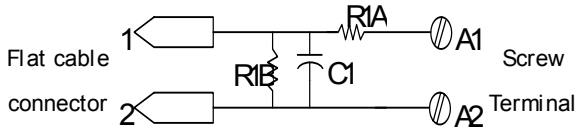

➤ **Straight-through connection (Default setting)**

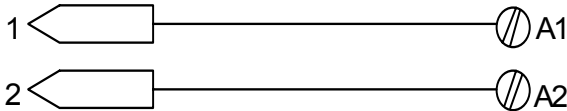

R1A = Short (0 Ω)
R1B and C1 = Open

➤ **Single-ended Voltage Attenuator**

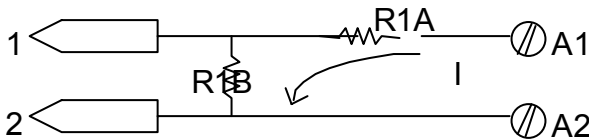

R2A = Short(0 Ω), C1 = Open,
Attenuation = $R1B / (R1A + R1B)$

Example : 10: 1 voltage attenuator
R1A = 9K Ω, and R1B = 1K Ω
Attenuation = $1 / (1 + 9)$

➤ **Low-pass filter (Single-ended Input)**

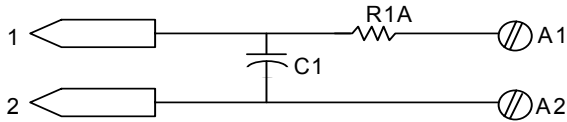

R2A = Short (0 Ω), R1B = Open

$$f_{3dB} = 1 / (2\pi R1A C1)$$

Example : 1.6 KHz low pass filter:

R1A = 10K Ω , C1 = 0.01 μ F

➤ **0-20mA Current-loop Input**

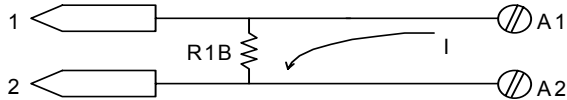

R1A = Short(0 Ω), C1 = Open,

R1B = 250 Ω (0.05% tolerance) for 0 to 5V VDC signal Converter.

4.4 Pin Assignment

Pin assignment of CAN

Pin	Description	Pin	Description
1	A1	11	A11
2	A2	12	A12
3	A3	13	A13
4	A4	14	A14
5	A5	15	A15
6	A6	16	A16
7	A7	17	A17
8	A8	18	A18
9	A9	19	A19
10	A10	20	A20

Pin assignment of CNB

Pin	Description	Pin	Description
1	B1	11	B11
2	B2	12	B12
3	B3	13	B13
4	B4	14	B14
5	B5	15	B15
6	B6	16	B16
7	B7	17	B17
8	B8	18	B18
9	B9	19	B19
10	B10	20	B20

4.5 Applications

The ACLD-9178 could be used on following products:

- ✓ ACL-8312/8316
- ✓ ACL-8216
- ✓ ACL-6126
- ✓ ACL-7120

ACLD-9188

This chapter describes how to install and use the ACLD-9138.

5.1 Introduction

The ACLD-9188 is a universal screw terminal board, which provides convenient connection points for 20-pin flat ribbon cable or shielded cable with 37-pin D-type connector. This panel is designed for field signal wiring in industrial applications.

For example, you can easily construct a low-pass filter, attenuator or current-to-voltage converter by adding resistors and capacitors onto the reserved circuit pads.

5.1.1 Features

The ACLD-9188 industrial terminal board provides the following features:

- Low cost universal screw terminals
- Black pads accommodate applications such as break detection, low-pass filter, current shut and voltage attenuator.
- Industrial type terminal blocks permit heavy-duty and reliable connection of signals.
- 40 screw terminal points for two 20-pin flat cable or DB-37 connectors.

5.2 Installation

5.2.1 What you have

In addition to this *User's Manual*, the package includes the following items:

- ACLD-9188 Industrial Terminal Board
- Cable
- Nylon standoffs for table-top or panel mounting.

If any of these items was missed or damaged, contact the dealer whom you purchased. Save the shipping materials and carton in case you want to ship or store the product in the future.

5.2.2 ACLD-9188 Layout

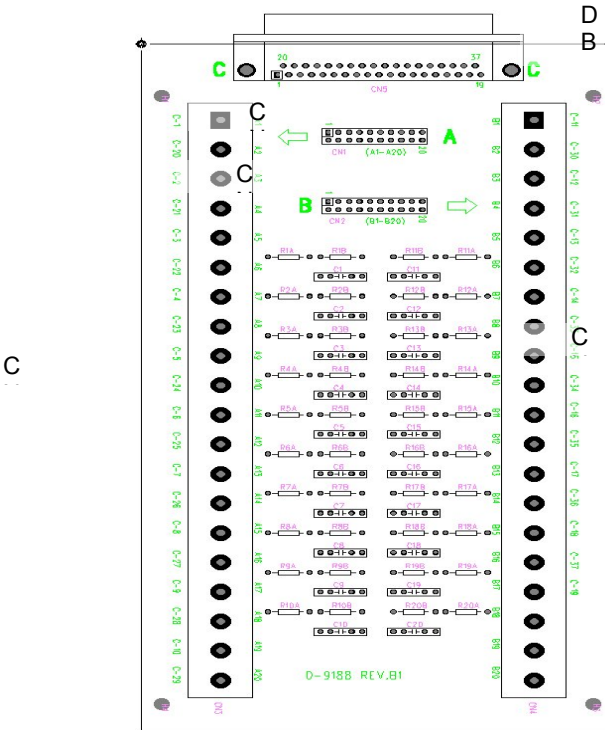

5.3 Signal Conditioning Circuits

The signal conditioning circuits of ACLD-9188 is the same as the circuits on ACLD-8125. Please refer to Section 4.3 for details.

You can connect the card and this terminal board with a DB-37 cable. The CN3 and CN1 are connected together, and so are the CN2 and CN4. If your application is sensitive signal, we suggest that please do not use flat cable connector and screw connector at the same time.

5.4 Pin Assignment

A1 to A20 is CN1.

B1 to B20 is CN2.

For example, the first field of the table means that A1(CN3-1), CN1-1, CN5-1 are connected together.

A1	CN1-1	CN5-1	B1	CN2-1	CN5-11
A2	CN1-2	CN5-20	B2	CN2-2	CN5-30
A3	CN1-3	CN5-2	B3	CN2-3	CN5-12
A4	CN1-4	CN5-21	B4	CN2-4	CN5-31
A5	CN1-5	CN5-3	B5	CN2-5	CN5-13
A6	CN1-6	CN5-22	B6	CN2-6	CN5-32
A7	CN1-7	CN5-4	B7	CN2-7	CN5-14
A8	CN1-8	CN5-23	B8	CN2-8	CN5-33
A9	CN1-9	CN5-5	B9	CN2-9	CN5-15
A10	CN1-10	CN5-24	B10	CN2-10	CN5-34
A11	CN1-11	CN5-6	B11	CN2-11	CN5-16
A12	CN1-12	CN5-25	B12	CN2-12	CN5-35
A13	CN1-13	CN5-7	B13	CN2-13	CN5-17
A14	CN1-14	CN5-26	B14	CN2-14	CN5-36
A15	CN1-15	CN5-8	B15	CN2-15	CN5-18
A16	CN1-16	CN5-27	B16	CN2-16	CN5-37
A17	CN1-17	CN5-9	B17	CN2-17	CN5-19
A18	CN1-18	CN5-28	B18	CN2-18	-
A19	CN1-19	CN5-10	B19	CN2-19	-
A20	CN1-20	CN5-29	B20	CN2-20	-

5.5 Applications

The ACLD-9188 could be used on following products:

- ✓ PCI-9114 Series
- ✓ PCI-9111 Series
- ✓ PCI-6208 Series
- ✓ PCI-8133,
- ✓ PCI-7200
- ✓ PCI-7230
- ✓ PCI-7250/7251
- ✓ ACL-8312/8316
- ✓ ACL-8112 Series
- ✓ ACL-8216
- ✓ ACL-8111
- ✓ ACL-6126
- ✓ ACL-7130
- ✓ ACL-7225.

6

ACLD-9138

This chapter describes how to install and use the ACLD-9138.

6.1 Introduction

The ACLD-9138 is an universal screw terminal board with 16 single-ended channels on board signal conditioning circuit. It could be used on our PCI and ACL series cards. There is a DB-37 connector. You can add your signal conditioning circuits on it. It provides the following features:

- 16 single-ended channels with on board signal conditioning circuits(pin 1-8, 20-27).
- Build-in screw terminals for wiring
- 37-pin D-sub connector
- On board LED for power status.

6.2 Installation

6.2.1 What you have

In addition to this *User's Manual*, the package includes the following items:

- ACLD-9138 Industrial Terminal Board
- Two 20-pin 1-meter flat cable

If any of these items was missed or damaged, contact the dealer whom you purchased. Save the shipping materials and carton in case you want to ship or store the product in the future.

6.2.2 ACLD-9138 Layout

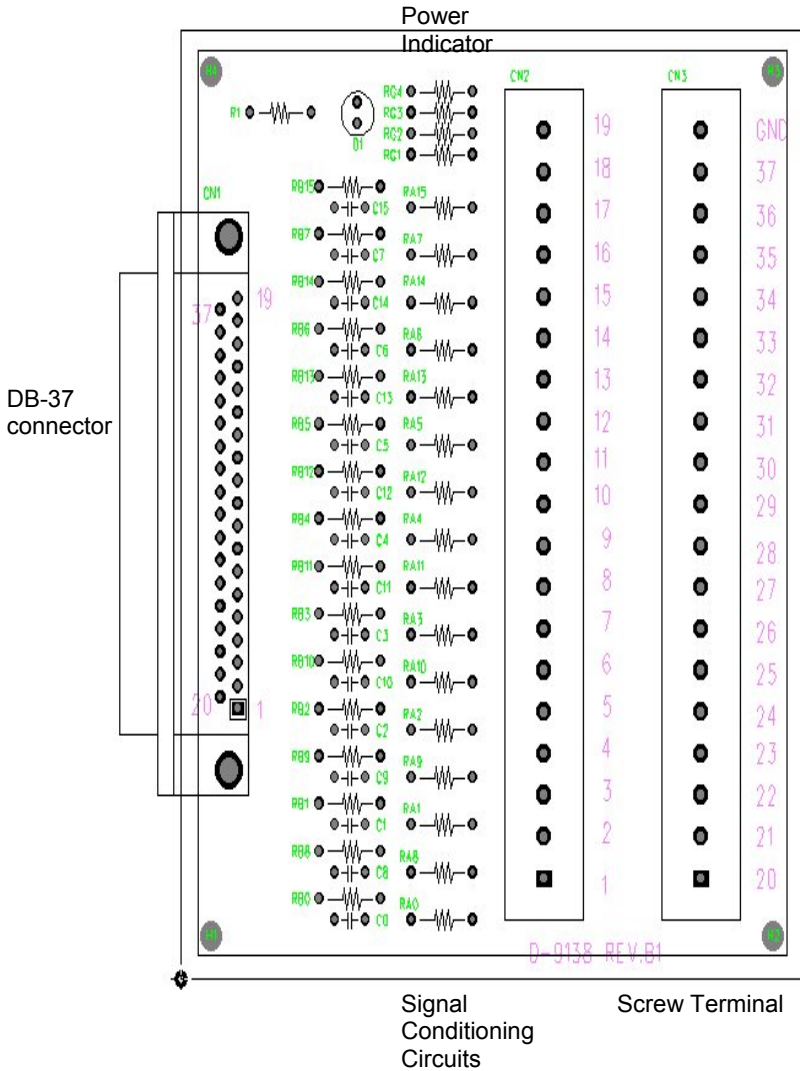

6.3 Using the ACLD-9138

6.3.1 Signal Conditioning Circuits

The signal conditioning circuits of ACLD-9138 is almost the same as ACLD-8125 and ACLD-9178. But the ACLD-9138 supports only single-ended connection, that means all your grounds are connected together. Please refer to Section 4.3 for details.

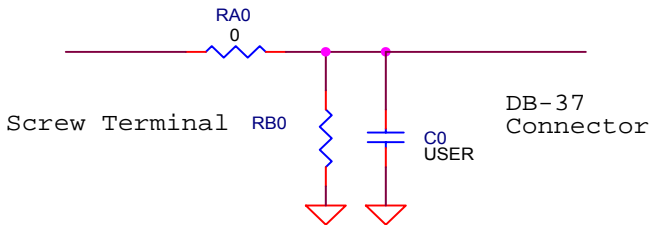

Please note that RA0 is a 0-ohm resistor. You can also change its value for different applications.

6.3.2 Power Indicator

There are on board power indicator.

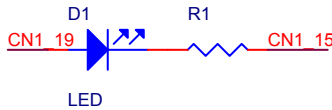

The power LED is crossed between pin 19 and 15 of the DB-37 connector. And the pin 9, 10, 28, 29 are connected to the external ground (GND of the screw terminal).

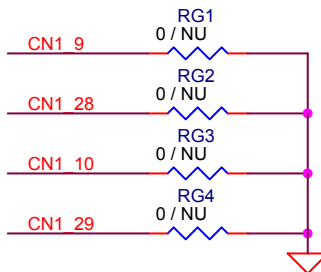

If your application is not been listed in section 6.4, you should take care about six pins listed above.

6.4 Applications

The ACLD-9138 could be used with the following products:

- ✓ PCI-9112
- ✓ PCI-9111 Series
- ✓ ACL-8312/8316
- ✓ ACL-8112 Series,
- ✓ ACL-8216.

6.5 Pin Assignment

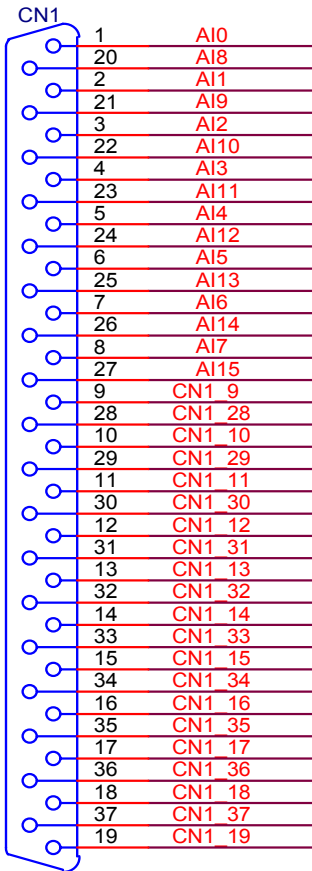

Pin	Meaning	Pin	Meaning
1	AI0	20	AI8
2	AI1	21	AI9
3	AI2	22	AI10
4	AI3	23	AI11
5	AI4	24	AI12
6	AI5	25	AI13
7	AI6	26	AI14
8	AI7	27	AI15
9	CN1_9	28	CN1_28
10	CN1_10	29	CN1_29
11	CN1_11	30	CN1_30
12	CN1_12	31	CN1_31
13	CN1_13	32	CN1_32
14	CN1_14	33	CN1_33
15	CN1_15	34	CN1_34
16	CN1_16	35	CN1_35
17	CN1_17	36	CN1_36
18	CN1_18	37	CN1_37
19	CN1_19		

7

ACLD-9881

This chapter describes how to install and use the ACLD-9881.

7.1 Introduction

The ACLD-9881 has a 37-pin D-sub connector, which can connect with PCI-9113A or ACL-8113A through 37-pin assemble cable. The ACLD-9881 provides low pass filter for the 32 channels, it is very flexible for wiring.

7.1.1 Features

The ACLD-9881 industrial terminal board provides the following features:

- Low cost universal screw terminals
 - On-board 37-pin D-sub female connector
 - Reliable screw clamp termination blocks
 - Shipped with one 1-meter ACL-10137 cable
-

7.2 Installation

7.2.1 What you have

In addition to this *User's Manual*, the package includes the following items:

ACLD-9881 Industrial Terminal Board

Cable

Nylon standoffs for table-top or panel mounting.

If any of these items was missed or damaged, contact the dealer whom you purchased. Save the shipping materials and carton in case you want to ship or store the product in the future.

7.2.2 ACLD-9881 Layout

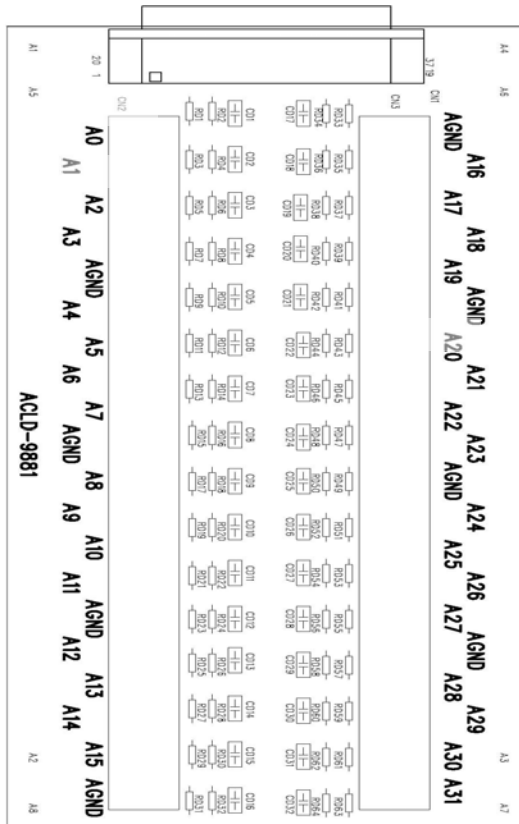

7.3 Signal Conditioning Circuits

There are 32 SE A/D channels on board. The R/C filters (attenuators) are on board for every channel. The RC circuits for each channel are shown in the following diagram, where 'n' is the channel number. User can install the R, C for special purpose such as attenuating the voltage to increase the input voltage range.

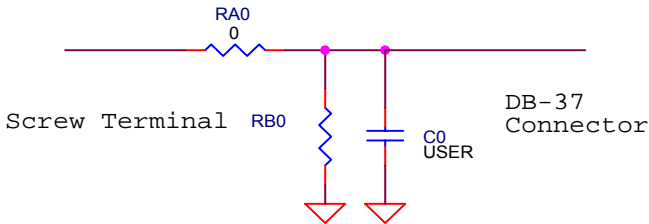

The RC network can also be used as current sensor, which transfers the current into voltage. To get the ground reference level, user can cut-off RA and let RB = 0 Ohm, thus grounding the input signal. The users can use the ground input to calibrate the offset voltage by software.

7.4 Applications

The ACLD-9881 could be used on following products:

- ✓ PCI-9113A
- ✓ ACL-8113A

7.5 Pin Assignment

A0	CN1-1	A20	CN1-13
A1	CN1-20	A21	CN1-32
A2	CN1-2	A22	CN1-14
A3	CN1-21	A23	CN1-33
A4	CN1-3	A24	CN1-15
A5	CN1-22	A25	CN1-34
A6	CN1-4	A26	CN1-16
A7	CN1-23	A27	CN1-35
A8	CN1-5	A28	CN1-17
A9	CN1-24	A29	CN1-36
A10	CN1-6	A30	CN1-18
A11	CN1-25	A31	CN1-37
A12	CN1-7	AGND	CN1-9, CN1-10, CN1-19, CN1-28, CN1-29
A13	CN1-26		
A14	CN1-8		
A15	CN1-27		
A16	CN1-11		
A17	CN1-30		
A18	CN1-12		
A19	CN1-31		

Product Warranty/Service

Seller warrants that equipment furnished will be free from defects in material and workmanship for a period of one year from the confirmed date of purchase of the original buyer and that upon written notice of any such defect, Seller will, at its option, repair or replace the defective item under the terms of this warranty, subject to the provisions and specific exclusions listed herein.

This warranty shall not apply to equipment that has been previously repaired or altered outside our plant in any way as to, in the judgment of the manufacturer, affect its reliability. Nor will it apply if the equipment has been used in a manner exceeding its specifications or if the serial number has been removed.

Seller does not assume any liability for consequential damages as a result from our products uses, and in any event our liability shall not exceed the original selling price of the equipment.

The equipment warranty shall constitute the sole and exclusive remedy of any Buyer of Seller's equipment and the sole and exclusive liability of the Seller, its successors or assigns, in connection with equipment purchased and in lieu of all other warranties expressed implied or statutory, including, but not limited to, any implied warranty of merchant ability or fitness and all other obligations or liabilities of seller, its successors or assigns.

The equipment must be returned postage-prepaid. Package it securely and insure it. You will be charged for parts and labor if you lack proof of date of purchase, or if the warranty period is expired.