





Introduction

The **TGAP-W610+/-W6610+-M12** are reliable outdoor WLAN access points with one (**TGAP-W610+**) or dual (**TGAP-W6610+**) 802.11 a/b/g/n wireless modules alongside one Gigabit LAN port in M12 connector. With EN50155 compliance and M12 connectors to ensure tight and robust connections, the devices guarantee reliable operation against vibration and shock, and are ideal for rolling stock applications. The devices have an IP-67 waterproof housing to protect them from damage in harsh weather when installed outdoors. Featuring two or four N-Type connectors that can house any N-Type antennas for extended communications distances, the devices are ideal for the toughest industrial environments. In addition, the LAN port of the devices is PoE-enabled, allowing the device to be powered over the existing network cable. The APs can be configured to operate in AP/Client/Bridge/AP-Client modes and support MAC filters for security control. Configurations and management can be done via a Web utility or Web interface on LAN or WLAN networks.

Package Contents



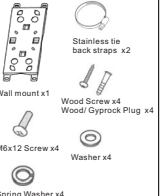

The **TGAP-W610+/6610+-M12** are shipped with the following items. If any of these items is missing or damaged, please contact your customer service representative for assistance.

Contents	Pictures	Number
TGAP-W610+-M12		1
TGAP-W6610+-M12		1
CD		1
2.4GHz/5GHz Antenna		2 (TGAP-W610+-M12) or 4 (TGAP-W6610+-M12)
QIG		1
Mounting Installation Package		1

Preparation

Before you begin installing the device, make sure you have all of the package contents available and a PC with Microsoft Internet Explorer 6.0 or later, for using web-based system management tools.

Safety & Warnings

-  When installed outdoors, make sure the connectors on the panel are facing down to prevent water intrusion.
-  Do not remove the water-proof casing, and do not touch or move the device when the antennas are transmitting or receiving signals.
-  When installing the device, make sure to keep the radiating at a minimum distance of 20 cm (7.9 inches) from all persons to minimize the potential for human contact during normal operation.
-  Do not operate the device near unshielded blasting caps or in an otherwise explosive environment unless the device has been modified for such use by qualified personnel.

Dimension

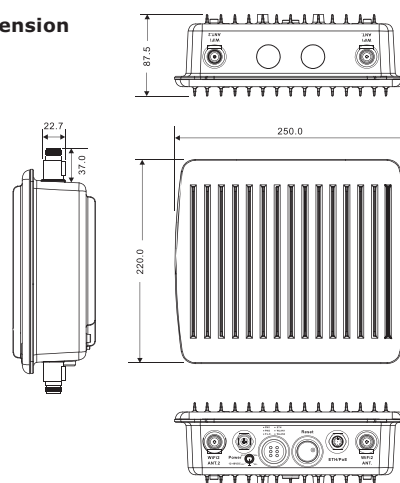

Panel Layouts

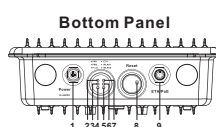

TGAP-W610+-M12

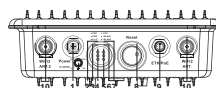

TGAP-W6610+-M12

1. Power connector
2. LED for PWR1 status
3. LED for PWR2 status
4. LED for PoE status
5. LED for WLAN2 connection
6. LED for WLAN1 connection
7. LED for LAN port connection
8. Reset button
9. LAN port
10. Connector for WiFi2 antenna

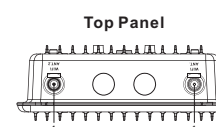

1. Antenna connector for WiFi (WiFi1)

Installation

The device can be fixed to a pole or the wall using the supplied mounting plate. Make sure the connectors on the bottom panel are facing down when installing to prevent water intrusion.

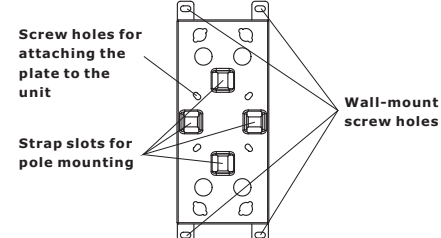

Wall-mount

Follow the steps below to install the device to the wall.
Step 1: Attach the mounting plate to the back of the device using four screws. The plate can be attached vertically or horizontally to the device depending on the space available.

Vertical

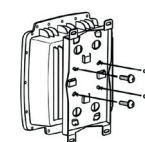

Horizontal

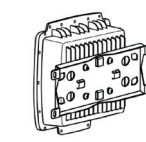
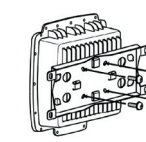

Step 2: Hold the device upright against the wall.

Step 3: Insert four screws through the holes at the top and bottom of the plate and fasten the screws to the wall.

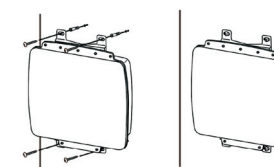

Pole-mount

You can mount the device to a pole using the adjustable steel band straps included in the kit. Follow the steps below:

Step 1: Attach the mounting plate to the back of the device using four screws. The plate can be attached vertically or horizontally to the device based on the space available.

Vertical

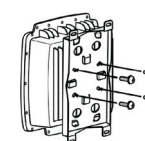

Horizontal

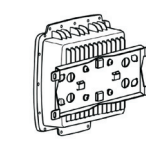
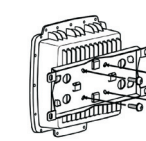

Step 2: Thread the two supplied metal mounting straps through the large slots on the mounting plate and then put the straps around the pole.

Type 1

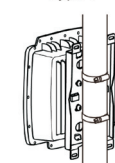

Type 2

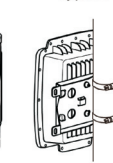

Type 3

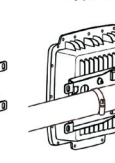

Wiring

For pin assignments of power, console and relay output ports, please refer to the following tables.

Grounding

Grounding and wire routing help limit the effects of noise due to electromagnetic interference (EMI). Run the ground connection from the grounding pin on the power connector to the grounding surface prior to connecting devices.

POWER PORT PINOUTS

The device supports two sets of power supplies and uses the M12 5-pin female connector on the front panel for the dual power inputs.
Step 1: Insert a power cable to the power connector on the device.
Step 2: Rotate the outer ring of the cable connector until a snug fit is achieved. Make sure the connection is tight.



Network Connection

The AP has one 10/100/1000 Base-T(X) Ethernet ports. According to the link type, the AP uses CAT 3, 4, 5, 5e, UTP cables to connect to any other network device (PCs, servers, devices, routers, or hubs). Please refer to the following table for cable specifications.

Cable	Type	Max. Length	Connector
10Base-T	Cat. 3, 4, 5 100-ohm	UTP 100 m (328 ft)	M12
100Base-T	Cat. 5 100-ohm UTP	UTP 100 m (328 ft)	M12
1000Base-T	Cat. 5/Cat. 5e 100-ohm UTP	UTP 100 m (328 ft)	M12

M12/8P Pin Definition

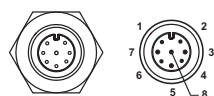

PIN	Definition
1	BI_DC+
2	BI_DD+
3	BI_DD-
4	BI_DA-
5	BI_DB+
6	BI_DA+
7	BI_DC-
8	BI_DB-

Configurations

After installing the router and connecting cables, start the device by turning on power. The green power LED should turn on. Please refer to the following table for LED indication.

LED	Color	Status	Description
PWR1	Green	On	DC power 1 activated
PWR2	Green	On	DC power 2 activated
PoE	Green	On	Power is supplied over Ethernet cable
ETH	Green	On	Port is linked
		Blinking	Transmitting Data
WLAN (1/2)	Green	On	WLAN activated
		Blinking	Transmitting WLAN data

Follow the steps below to log in and access the system:

1. Launch the Internet Explorer and type in IP address of the device. The default static IP address is **192.168.10.2**

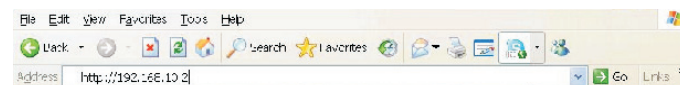

2. Log in with default user name and password (both are **admin**).

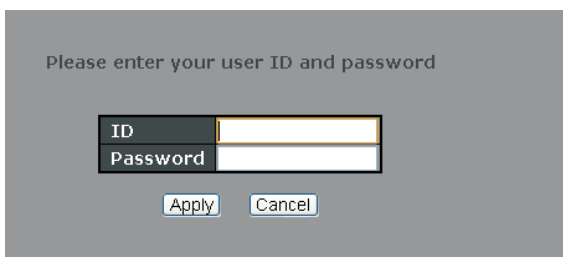

3. After logging in, you should see the following screen. For more information on configurations, please refer to the user manual. For information on operating the device using ORing's Open-Vision management utility, please go to ORing website.

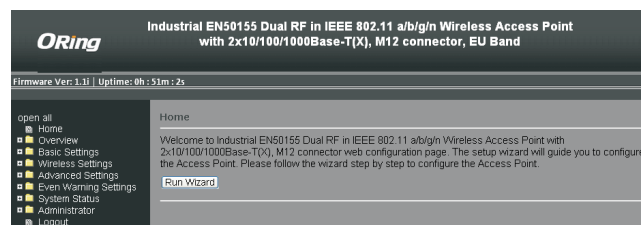

Resetting

To restore the device configurations back to the factory defaults, press the **Reset** button for a few seconds. Once the power indicator starts to flash, release the button. The device will then reboot and return to factory defaults.

Specifications

ORing WLAN Access Point Model	TGAP-W6610+-M12	TGAP-W610+-M12
Physical Ports		
10/100/1000Base-T(X) Ports in M12 Auto MDI/MDIX (8-pin A-coding)	1	
PoE P.D. port	Present at ETH Fully compliant with IEEE 802.3af Power Device specification Over load & short circuit protection Isolation Voltage: 1000 VDC min Isolation Resistance: 10 ⁹ ohms min	
WLAN Interface		
Operating Mode	Dual AP/Dual Client /Bridge /AP-Client Mode	AP/Client /Bridge /AP-Client Mode
Antenna and Connector	4 x External N type antenna connector	2 x External N type antenna connector
Radio Frequency Type	DSSS, OFDM	
Modulation	IEEE802.11b: CCK, DQPSK, DBPSK IEEE802.11g: OFDM with BPSK, QPSK, 16QAM, 64QAM IEEE802.11a: OFDM with BPSK, QPSK, 16QAM, 64QAM IEEE802.11n: OFDM with BPSK, QPSK, 16QAM, 64QAM	
Frequency Band	America / FCC : 2.412~2.462 GHz (11 channels) 5.180~5.240 GHz & 5.745~5.825 GHz (9 channels) Europe CE / ETSI : 2.412~2.472 GHz (13 channels) 5.180~5.240 GHz (4 channels)	
Transmission Rate	IEEE802.11b: 1/ 2/ 5.5/ 11 Mbps IEEE802.11a/g: 6/ 9/ 12/ 18/ 24/ 36/ 48/ 54 Mbps IEEE802.11n: up to 300Mbps	
Transmit Power	802.11a: 12dBm ± 1.5 dBm 802.11b: 18dBm ± 1.5 dBm 802.11g: 15dBm ± 1.5 dBm 802.11gn HT20: 13dBm ± 1.5 dBm@150Mbps 802.11gn HT40: 12dBm ± 1.5 dBm@300Mbps 802.11an HT20: 12dBm ± 1.5 dBm@150Mbps 802.11an HT40: 12dBm ± 1.5 dBm@300Mbps	
Receiver Sensitivity	802.11a: -68dBm±2.0dB @ 54 Mbps 802.11b: -82dBm±2.0dB @ 11Mbps 802.11g: -68dBm±2.0dB @ 54Mbps 802.11gn HT20: -64dBm±2.0dB @ 150Mbps 802.11gn HT40: -60dBm±2.0dB @ 300Mbps 802.11an HT20: -64dBm±2.0dB @ 150Mbps 802.11an HT40: -60dBm±2.0dB @ 300Mbps	
Encryption Security	WEP: (64-bit, 128-bit key supported) WPA/WPA2: (WEP and AES encryption) 802.11i WPA-PSK (256-bit key pre-shared key supported) 802.1X Authentication supported TKIP encryption	
Wireless Security	SSID broadcast disable	

Protocol Support	
Protocol	ARP, BOOTP, DHCP, DNS, HTTPs, IP, ICMP, SNMP, TCP, UDP, RADIUS, SNMP, STP, RSTP
LED Indicators	
Power Indicator	3 x LEDs, PW1/ PW2/ PoE Green On : Power is on and booting up PW1/ PW2/ PoE
10/100/1000Base-T(X) port Indicator	1 x LED, Green for port Link/Act
WLAN LED	2 x LEDs, Green for WLAN Link/Ack 1 x LED, Green for WLAN Link/Ack
Power	
Power Consumption (Typ.)	11 Watts 9 Watts
Physical Characteristic	
Enclosure	IP-67
Dimension (W x D x H)	310(W) x 310(D) x 87(H) mm (12.2 x 12.2 x 3.4 inch.)
Weight (g)	3980 g 3900 g
Environmental	
Storage Temperature	-40 to 85°C (-40 to 185°F)
Operating Temperature	-25 to 70°C (-13 to 158°F)
Operating Humidity	5% to 95% Non-condensing
Regulatory Approvals	
EMI	FCC Part 15, CISPR (EN55022) class A, EN50155 (EN50121-3-2, EN55011, EN50121-4)
EMS	EN61000-4-2 (ESD), EN61000-4-3 (RS), EN61000-4-4 (EFT), EN61000-4-5 (Surge), EN61000-4-6 (CS), EN61000-4-8, EN61000-4-11
Shock	IEC60068-2-27, EN61373
Free Fall	IEC60068-2-32
Vibration	IEC60068-2-6, EN61373
Rail Traffic	EN50155
Cooling	EN60068-2-1
Dry Heat	EN60068-2-2
Safety	EN60950-1
Warranty	5 years

Copyright © 2014 ORing
All rights reserved.



ORing Industrial Networking Corp.
 TEL: +886-2-2218-1066 Website: www.oring-networking.com
 FAX: +886-2-2218-1014 E-mail: support@oring-networking.com