



ADLINK
TECHNOLOGY INC.

PCIe-GIE62
2-CH Gigabit Ethernet Vision
(GigE Vision) Interface Card

User's Manual

Manual Rev. 2.00
Revision Date: July 31, 2007
Part No: 51-18015-0A10



Recycled Paper

Advance Technologies; Automate the World.



Copyright 2008 ADLINK TECHNOLOGY INC.

All Rights Reserved.

The information in this document is subject to change without prior notice in order to improve reliability, design, and function and does not represent a commitment on the part of the manufacturer.

In no event will the manufacturer be liable for direct, indirect, special, incidental, or consequential damages arising out of the use or inability to use the product or documentation, even if advised of the possibility of such damages.

This document contains proprietary information protected by copyright. All rights are reserved. No part of this manual may be reproduced by any mechanical, electronic, or other means in any form without prior written permission of the manufacturer.

Trademarks

NuDAQ, NuIPC, DAQBench are registered trademarks of ADLINK TECHNOLOGY INC.

Product names mentioned herein are used for identification purposes only and may be trademarks and/or registered trademarks of their respective companies.

Getting Service from ADLINK

Customer Satisfaction is top priority for ADLINK Technology Inc. Please contact us should you require any service or assistance.

ADLINK TECHNOLOGY INC.

Web Site: <http://www.adlinktech.com>
 Sales & Service: Service@adlinktech.com
 TEL: +886-2-82265877
 FAX: +886-2-82265717
 Address: 9F, No. 166, Jian Yi Road, Chungho City,
 Taipei, 235 Taiwan

Please email or FAX this completed service form for prompt and satisfactory service.

Company Information	
Company/Organization	
Contact Person	
E-mail Address	
Address	
Country	
TEL	FAX:
Web Site	
Product Information	
Product Model	
Environment	OS: M/B: CPU: Chipset: BIOS:

Please give a detailed description of the problem(s):

Table of Contents

List of Tables	ii
List of Figures	iii
1 Introduction	1
1.1 Features.....	2
1.2 Applications	2
2 Hardware Reference	3
2.1 PCIe-GiE62	3
PCIe-GiE62 Specification	3
PCIe-GiE62 Connectors & Pin Definitions	4
3 Installation Guide	13
3.1 Hardware Installation	13
3.2 Driver Installation	14
4 Function Library	21
4.1 Function List	21
4.2 Functions	22
GiE62_Initialize	22
GiE62_GetTotalDeviceNum	23
GiE62_GetTotalDeviceID	24
GiE62_OpenDevice	25
GiE62_ResetDevice	26
GiE62_GetFirmwareVersion	27
GiE62_SetDOSStatus	28
GiE62_GetDIStatus	29
GiE62_SetTriggerDelayTime	30
GiE62_SetTriggerOutWidth	31
GiE62_SetTriggerOutPolarity	32
GiE62_SetTriggerInPolarity	33
GiE62_GetTriggerDelayTime	34
GiE62_GetTriggerOutWidth	35
GiE62_GetTriggerOutPolarity	36
GiE62_GetTriggerInPolarity	37
4.3 Error Codes	38

List of Tables

Table 2-1:	J2 RJ-45: LAN 1 Port	5
Table 2-2:	J3 RJ-45: LAN 2 Port	5
Table 2-3:	LED1: LAN 1 status LED	6
Table 2-4:	LED2: LAN 2 status LED	6
Table 2-5:	SW1: Card ID Select	7
Table 2-6:	Card ID Select Table	7
Table 2-7:	CN3: GPIO & Trigger	8
Table 2-8:	Extension Cable Connector: D-sub 15 Pin Female	12
Table 4-1:	Error Codes	38

List of Figures

Figure 2-1: PCIe-GIE62 Layout 4

1 Introduction

The ADLINK PCIe-GIE62 is a PCI Express x4 lane, Gigabit Ethernet (GbE) network interface card (NIC), which supports 2 independent Gigabit Ethernet ports for multiple GigE Vision device connections with data transfer rates up to 1000 Mb/s, like most of the GigE Vision cameras.

The PCIe-GIE62 provides two isolated digital inputs and outputs for connecting to external devices such position sensors. The PCIe-GIE62 also includes two isolated programmable Trigger output pulses to manage trigger events such as activating a strobe lighting.

The GigE Vision is an open standard that allows industrial camera to communication with computer with existing Ethernet technology. It leverages Ethernet technology for machine vision applications, and takes advantage of the proven capabilities, such as long distance transmission, and high bandwidth.

1.1 Features

- ▶ Supports two independent GbE ports
- ▶ Supports jumbo frames (9 KByte)
- ▶ PCI Express x4 compliant
- ▶ Provides Industrial screw lock connector
- ▶ 2 isolation digital inputs/outputs
- ▶ 2 isolation TTL level programmable trigger output pulses
- ▶ Supports windows XP/XP embedded/Vista

1.2 Applications

- ▶ Machine Vision Inspection System
- ▶ Scientific Research Instrumentation
- ▶ Medical Research Instrumentation

2 Hardware Reference

2.1 PCIe-GIE62

2.1.1 PCIe-GIE62 Specification

Ethernet Port

- ▶ Two full-integrated Gigabit Ethernet Media Access Control (MAC) and physical layer (PHY) ports.
- ▶ Gigabit Ethernet Controller provides a standard IEEE 802.3 Ethernet interface for 1000BASE-T, 100BASE-TX, and 10BASE-T applications (802.3, 802.3u, and 802.3ab).
- ▶ 9 kB jumbo frame support

IO trigger Function

- ▶ 2 Isolated Digital Input
- ▶ 2 Isolated Digital Output
- ▶ 2 Isolated trigger Input
- ▶ 2 Isolated trigger Output

Isolated Voltage

- ▶ Rated Isolation Voltage 1000V @ 60 seconds

Form Factor

- ▶ X4 PCI-express interface

Dimensions

- ▶ W x L: 129.5 x 111.15 mm

Operating Environment

- ▶ Temperature: 0 to 55°C
- ▶ Humidity: 5 to 90% RHNC

Storage Environment

- ▶ Temperature: 0 to 85°C
- ▶ Humidity: 0 to 95% RHNC

Power Requirements

- ▶ PCIe-GIE62: +12 V max @ 0.2 A, +3.3 V max @ 1.5 A

2.1.2 PCIe-GIE62 Connectors & Pin Definitions

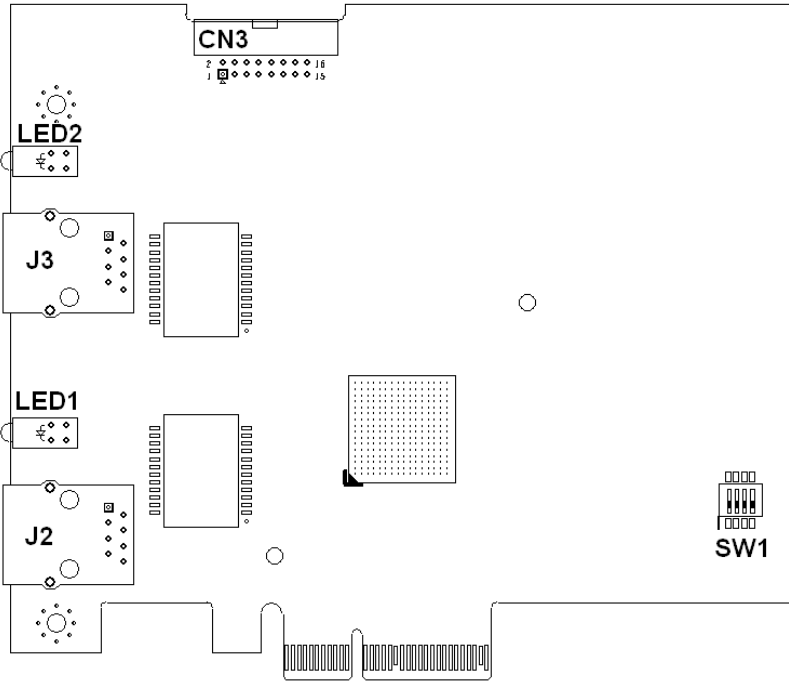
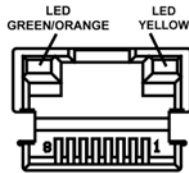

Figure 2-1: PCIe-GIE62 Layout

J2, J3 RJ-45 Ethernet Port

► J2 RJ-45: LAN 1 Port



Pin	Signal	Pin	Signal
1	MDI0+	5	MDI2-
2	MDI0-	6	MDI1-
3	MDI1+	7	MDI3+
4	MDI2+	8	MDI3-

Table 2-1: J2 RJ-45: LAN 1 Port

► J3 RJ-45 : LAN 2 port

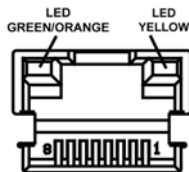

Pin	Signal	Pin	Signal
1	MDI0+	5	MDI2-
2	MDI0-	6	MDI1-
3	MDI1+	7	MDI3+
4	MDI2+	8	MDI3-

Table 2-2: J3 RJ-45: LAN 2 Port

LED1: LAN 1 status LED

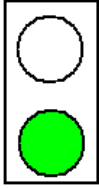

LED Color	Color	Function
Bi color (Speed status)	Table 1: Orange	Table 2: 1000Mbps
	Green	100Mbps
	OFF	10Mbps
Green (Link status)	ON	Link
	OFF	Link off
	Blinking	Data transfer in progress

Table 2-3: LED1: LAN 1 status LED

LED2 : LAN 2 status LED

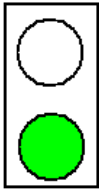

LED Color	Color	Function
Bi color (Speed status)	Table 3: Orange	Table 4: 1000Mbps
	Green	100Mbps
	OFF	10Mbps
Green (Link status)	ON	Link
	OFF	Link off
	Blinking	Data transfer in progress

Table 2-4: LED2: LAN 2 status LED

SW1: Card ID Select

Card ID Max. support 4 cards

► SW1

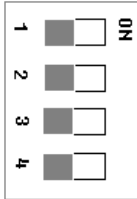

Pin no	Signal Name	Default
1	Board ID Select 0	OFF
2	Board ID Select 1	OFF
3	Non use	OFF
4	Non use	OFF

Table 2-5: SW1: Card ID Select

Card ID	Board ID Select 0	Board ID Select 1
0	OFF	OFF
1	ON	OFF
2	OFF	ON
3	ON	ON

Table 2-6: Card ID Select Table

CN3: GPIO & Trigger

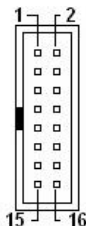

PIN	PIN NAME	TYPE	PIN	PIN NAME	TYPE
1	In01	IN	2	ComI01	IN
3	In02	IN	4	ComI02	IN
5	Out01	OUT	6	ComO01	OUT
7	Out02	OUT	8	ComO02	OUT
9	TrgIn1	IN	10	TrgComI01	IN
11	TrgIn2	IN	12	TrgComI02	IN
13	TrgOut1	OUT	14	TrgOut2	OUT
15	Frame Ground	OUT	16		

Table 2-7: CN3: GPIO & Trigger

Digital Input Circuit

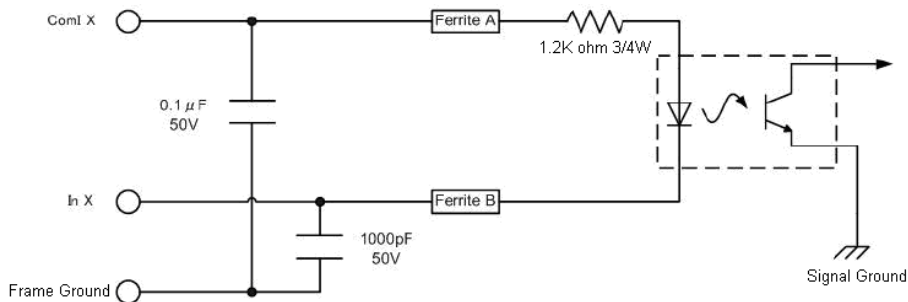

Digital Output Circuit

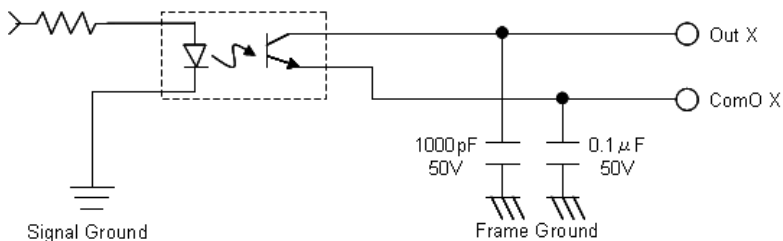

Trigger Input Circuit

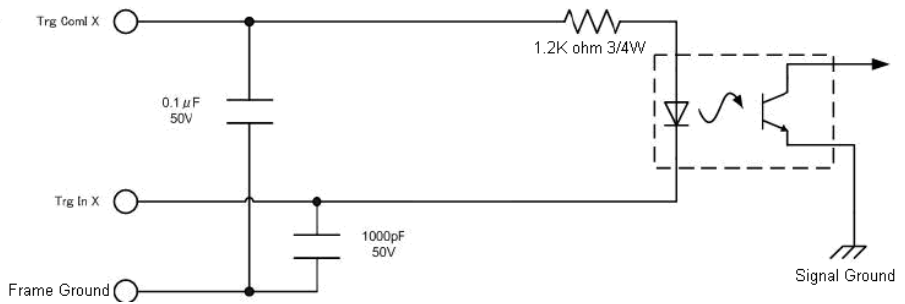

Trigger Output Circuit

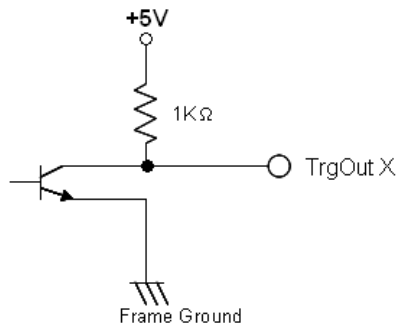

Function	Electronic Specification
Isolated Digital Input	Photo Coupled Input x 2 ch
Input voltage range	0 to 25V
Low level	0 to 0.5V
High Level	2 to 25V
Isolated Digital Output	Photo Coupled Output x 2 ch
Load voltage range	3 to 24V
Output sink current	80mA (Max)
Output voltage drop	1.0V (Max)
Leak current	0.1mA (Max)
Reverse voltage	-6V
Isolated Trigger Input	Photo Coupled Trigger input x 2 ch
Input voltage range	0 to 25V
Low level	0 to 0.5V
High level	2.7 to 25V
Polarity	Positive / Negative Selectable
Minimum pulse width	0.1msec
Isolated Trigger out	Photo Coupled Trigger output x 2 ch
Load voltage range	0 to 5V
Output sink current	40mA (Max)
Output voltage drop	0.4V Max(@16mA)
Trigger Out Control	
Trigger delay	0 msec to 1000msec selectable (1 msec step)
Trigger out pulse width	0.1 msec to 50msec selectable (0.1 msec step)
Polarity	Positive / Negative Selectable
Enable Control	Enable/Disable

Trigger Control Timing Chart

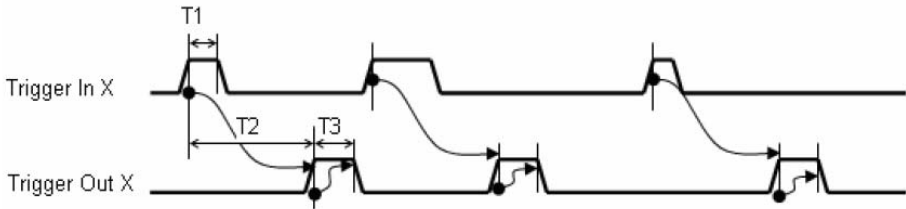

Symbol	Characteristic	Specification
T1	Trigger input pulse width	0.1 msec (Min.)
T2	Trigger delay	0 to 1000 msec Selectable (1 msec step) Actual delay = Selected delay time
T3	Output trigger pulse width	0.1 to 50 msec Selectable (0.1 msec step)

Trigger Busy Control

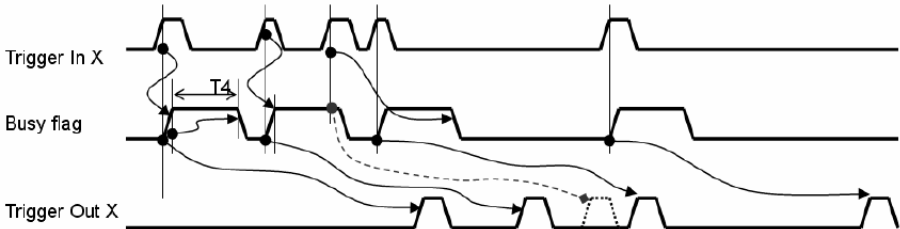

Symbol	Characteristic	Specification
T4	Trigger busy timer	T3 + 0.1 msec. Busy flag is set and trigger busy timer starts counting, when Trigger In signal is detected. Trigger busy flag is reset when trigger busy timer finish counting. During trigger busy flag is set, Trigger In signal are ignored.

Trigger Enable Control

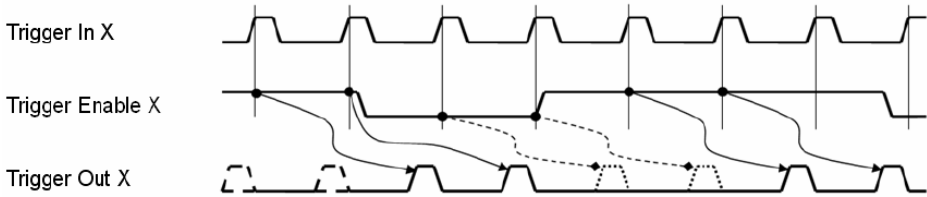

Extension Cable Connector: D-sub 15 Pin Female

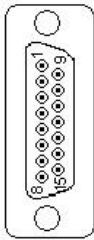

PIN	PIN NAME	TYPE	PIN	PIN NAME	TYPE
1	In01	IN	9	ComI01	IN
2	In02	IN	10	ComI02	IN
3	Out01	OUT	11	ComO01	OUT
4	Out02	OUT	12	ComO02	OUT
5	TrgIn1	IN	13	TrgComI01	IN
6	TrgIn2	IN	14	TrgComI02	IN
7	TrgOut1	OUT	15	TrgOut2	OUT
8	Frame Ground	OUT			

Table 2-8: Extension Cable Connector: D-sub 15 Pin Female

3 Installation Guide

3.1 Hardware Installation

Use the following steps to install the PCIe-GiE62 series board on the PCI express bus:

1. Remove the computer cover using the instructions from the computer manual.
2. Check that there is an empty PCI express slot. If there is not an empty slot, remove a PCI express board from the computer to make room for the PCIe-GiE62 board and take note of the chosen slot number.
3. Remove the blank metal plate located at the back of the selected slot (if any). Keep the removed screw to fasten the PCIe-GiE62 board after installation.
4. Carefully position the PCIe-GiE62 in the selected PCI express slot. If using a tower computer, align the board with the board slots.
5. Press the board firmly, but carefully into the connector.
6. Anchor the board by replacing the screw.
7. Connect device via a Gigabit Ethernet connector.
8. Turn on the computer.

Note: The PCIe-GiE62 can be installed in a PCI express x4, x8, and x16 slot.

3.2 Driver Installation

1. Double Click PRO2KXP.exe (for 2K/XP) or PRO-VISTA.exe (for Vista) to start driver installation of Intel network chipsets according to your operating system.

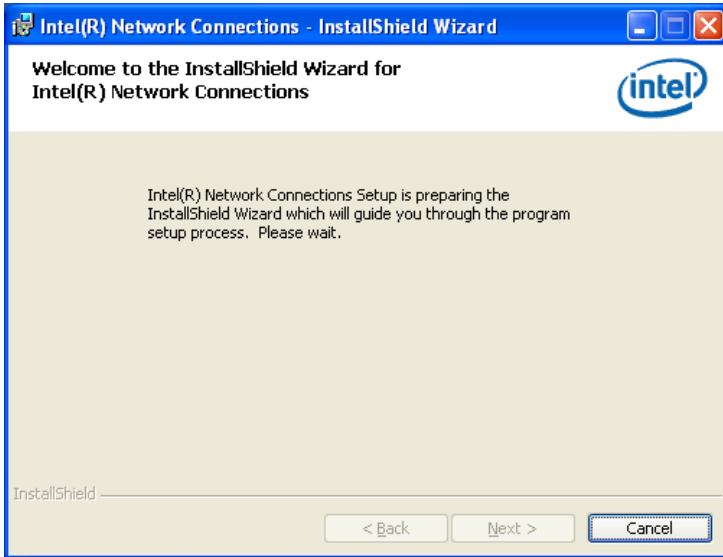

2. Click “Next” to continue driver installation.

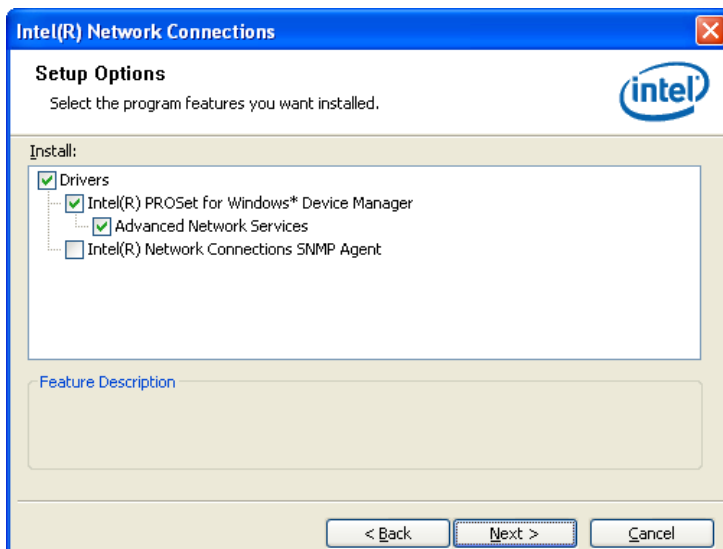
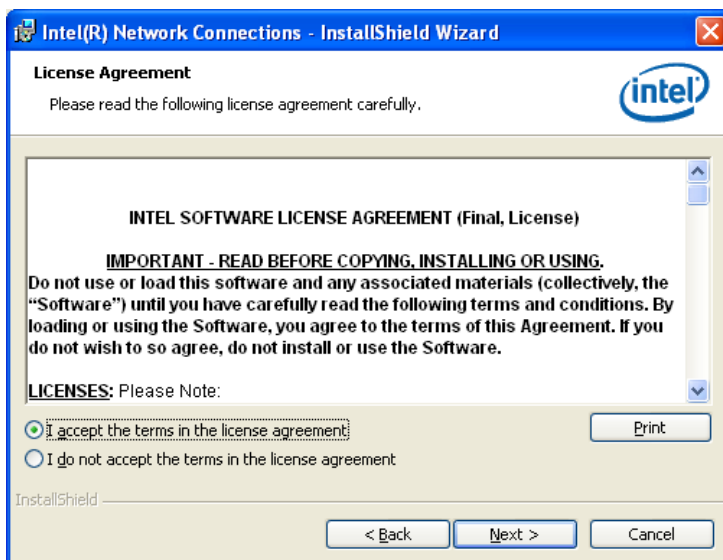

3. Click “Install” to start installing.

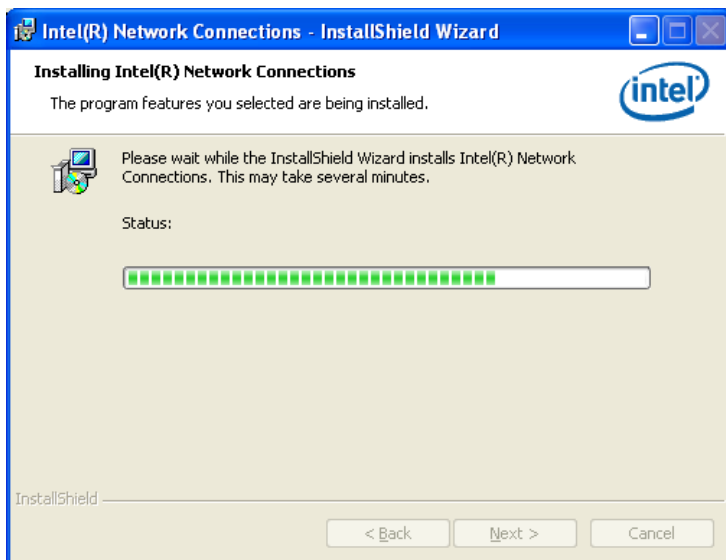
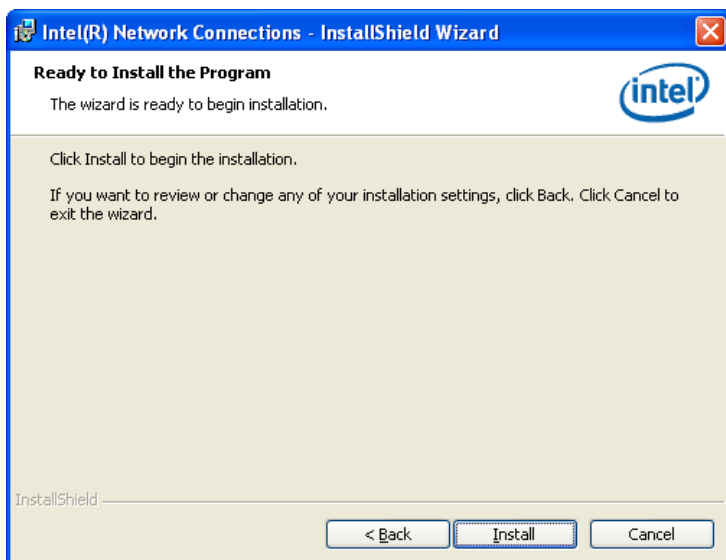

4. Click “Finish” to end driver installation.

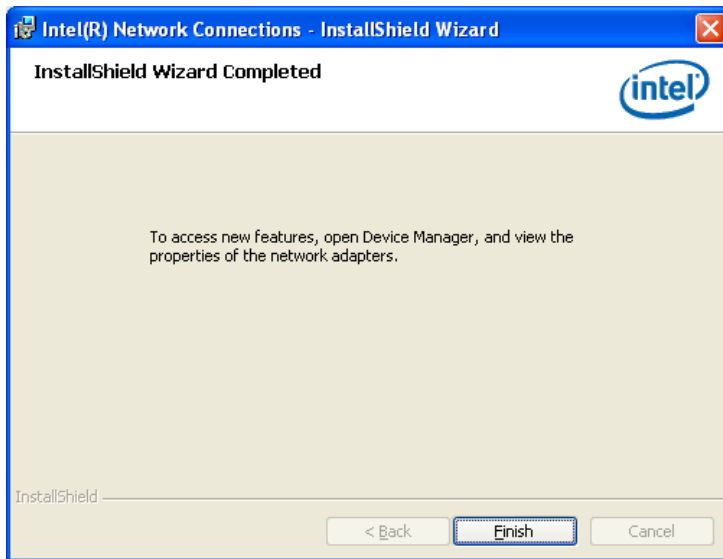

5. Go to the “Device Manager” and check “Network adapters”. You should see the following items:

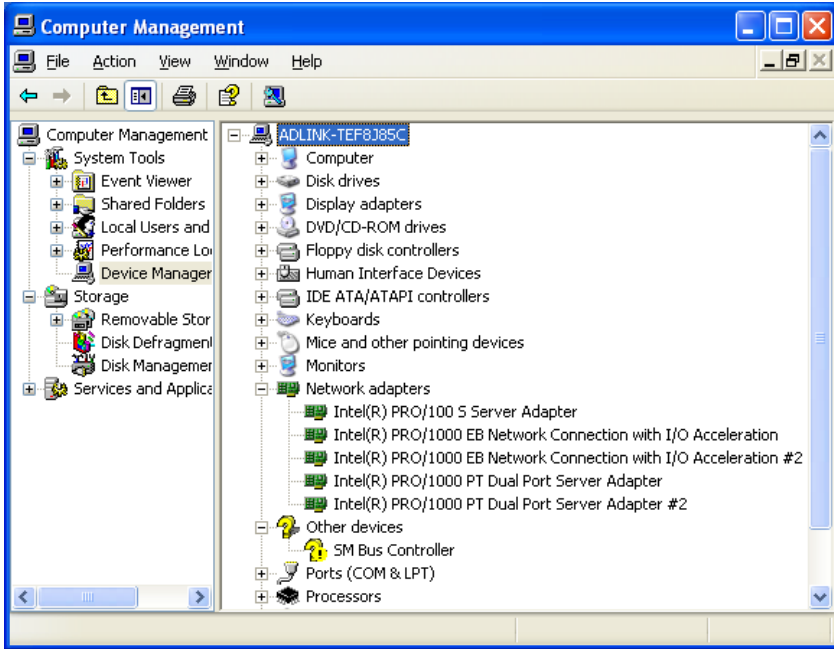

- ▷ Intel(R) PRO/100 S Server Adapter
- ▷ Intel(R) PRO/1000 EB Network Connection with I/O Acceleration
- ▷ Intel(R) PRO/1000 EB Network Connection with I/O Acceleration #2
- ▷ Intel(R) PRO/1000 PT Dual Port Server Adapter
- ▷ Intel(R) PRO/1000 PT Dual Port Server Adapter #2

6. Double Click GiE62_SetupDisk_1001.exe to start driver installation of ADLINK GiE62.



7. Click "Next" to continue driver installation.

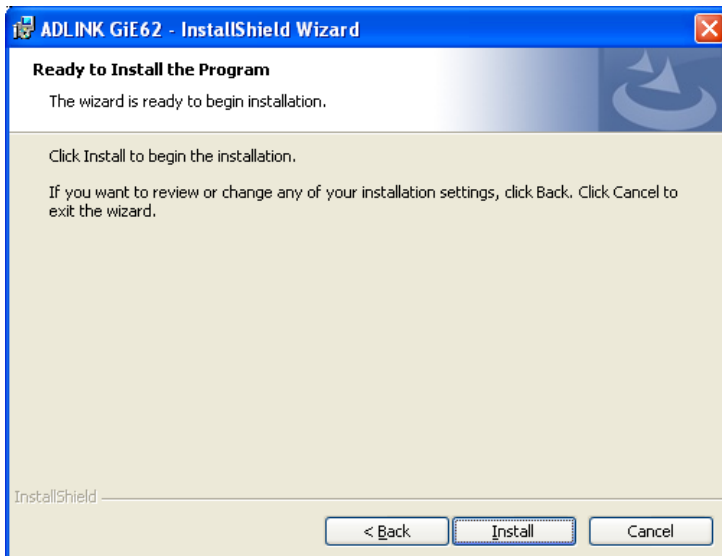

8. Click “Install” to start installing.

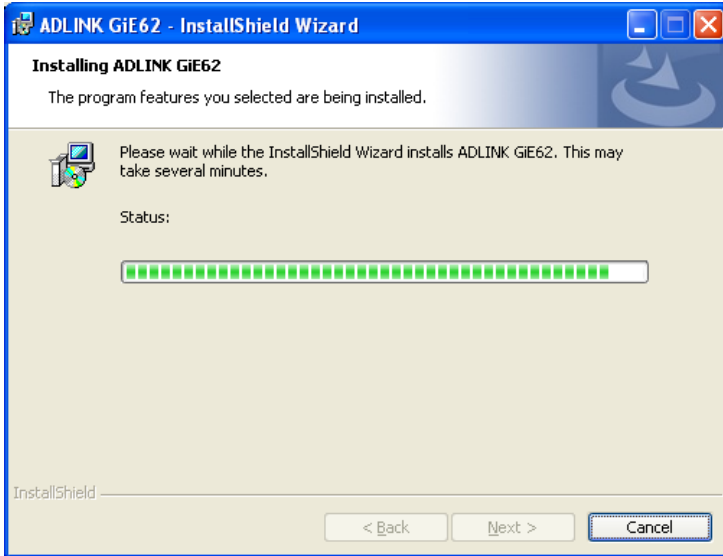

9. Click “Finish” to end driver installation.

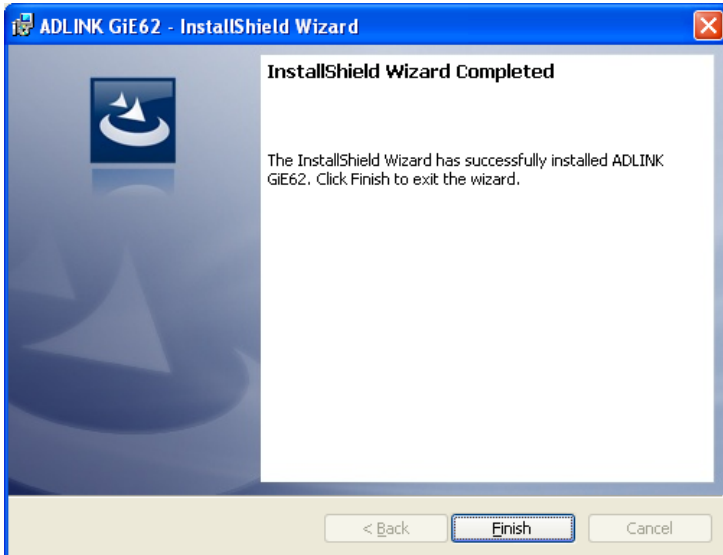

4 Function Library

4.1 Function List

Function name	Description
System Functions	
GiE62_Initialize	Load the driver of GiE62 card. You must call this function before any other functions
GiE62_GetTotalDeviceNum	Get the number of GiE62 cards in your system
GiE62_GetTotalDeviceID	Get the CardID(s) of each GiE62 cards in your system
GiE62_OpenDevice	Open GiE62 card and set it to the default status
GiE62_ResetDevice	Reset GiE62 card to the default status
GiE62_GetFirmwareVersion	Get the firmware version of GiE62 card
DIO Functions	
GiE62_SetDOStatus	Set general purpose digital output status
GiE62_GetDIStatus	Get general purpose digital input status
Trigger Functions	
GiE62_SetTriggerDelayTime	Set the delay time of output triggers
GiE62_SetTriggerOutWidth	Set the width of output triggers
GiE62_SetTriggerOutPolarity	Set the output polarity of output triggers
GiE62_SetTriggerInPolarity	Set the input polarity of output triggers
GiE62_GetTriggerDelayTime	Get the delay time of output triggers
GiE62_GetTriggerOutWidth	Get the width of output triggers
GiE62_GetTriggerOutPolarity	Get the output polarity of output triggers
GiE62_GetTriggerInPolarity	Get the input polarity of output triggers

4.2 Functions

4.2.1 GiE62_Initialize

Description

Load the driver of GiE62 card. You must call this function before any other functions.

Syntax

```
int GiE62_Initialize();
```

4.2.2 GiE62_GetTotalDeviceNum

Description

Get the number of GiE62 cards in your system.

Syntax

```
int GiE62_GetTotalDeviceNum();
```

4.2.3 GiE62_GetTotalDeviceID

Description

Get the CardID(s) of each GiE62 cards in your system.

Syntax

```
int GiE62_GetTotalDeviceID(int *DeviceID);
```

Parameters

DeviceID

[out] Pointer to a 32-bit integer array which stores the read out CardID(s).

4.2.4 GiE62_OpenDevice

Description

Open GiE62 card to the default status.

Syntax

```
int GiE62_OpenDevice(int CardID);
```

Parameters

CardID

[in] Card ID of GiE62. The card ID could be 0, 1, 2 and 3. It is defined by the DIP switch on GiE62.

4.2.5 GiE62_ResetDevice

Description

Reset GiE62 card and set it to the default state.

Syntax

```
int GiE62_ResetDevice(int CardID);
```

Parameters

CardID

[in] Card ID of GiE62. The card ID could be 0, 1, 2 and 3. It is defined by the DIP switch on GiE62.

4.2.6 GiE62_GetFirmwareVersion

Description

Get the firmware version of GiE62 card.

Syntax

```
int GiE62_GetFirmwareVersion(int CardID, char  
*FirmwareVersion, int StringSize);
```

Parameters

CardID

[in] Card ID of GiE62. The card ID could be 0, 1, 2 and 3. It is defined by the DIP switch on GiE62.

port

[out] Pointer to a character array which stores the read out firmware version.

status

[in] Size of the character array that will be returned.

4.2.7 GiE62_SetDOStatus

Description

Set general purpose digital output status.

Syntax

```
int GiE62_SetDOStatus(int CardID, int port, int  
status);
```

Parameters

CardID

[in] Card ID of GiE62. The card ID could be 0, 1, 2 and 3. It is defined by the DIP switch on GiE62.

port

[in] Port number of GiE62. The port number could be 1 and 2.

status

[in] A 32-bit integer variable which represents the status of digital output.

- ▷ 0: Low
- ▷ 1: High

4.2.8 GiE62_GetDIStatus

Description

Get general purpose digital input status.

Syntax

```
int GiE62_GetDIStatus(int CardID, int port, int  
*status);
```

Parameters

CardID

[in] Card ID of GiE62. The card ID could be 0, 1, 2 and 3. It is defined by the DIP switch on GiE62.

port

[in] Port number of GiE62. The port number could be 1 and 2.

status

[out] Pointer to a 32-bit integer variable which stores the read out digital input status.

4.2.9 GiE62_SetTriggerDelayTime

Description

Set the delay time of output triggers.

Syntax

```
int GiE62_SetTriggerDelayTime(int CardID, int port,  
int DelayTime);
```

Parameters

CardID

[in] Card ID of GiE62. The card ID could be 0, 1, 2 and 3. It is defined by the DIP switch on GiE62.

port

[in] Port number of GiE62. The port number could be 1 and 2.

DelayTime

[in] A 32-bit integer variable which specifies the delay time of output triggers.

The value should be 0 - 1000.

4.2.10 GiE62_SetTriggerOutWidth

Description

Set the width of output triggers.

Syntax

```
int GiE62_SetTriggerOutWidth(int CardID, int port,  
int width);
```

Parameters

CardID

[in] Card ID of GiE62. The card ID could be 0, 1, 2 and 3. It is defined by the DIP switch on GiE62.

port

[in] Port number of GiE62. The port number could be 1 and 2.

width

[in] A 32-bit integer variable which specifies the width of output triggers.

The value should be 0 - 500.

4.2.11 GiE62_SetTriggerOutPolarity

Description

Set the output polarity of output triggers.

Syntax

```
int GiE62_SetTriggerOutPolarity(int CardID, int  
port, int OutPolarity);
```

Parameters

CardID

[in] Card ID of GiE62. The card ID could be 0, 1, 2 and 3. It is defined by the DIP switch on GiE62.

port

[in] Port number of GiE62. The port number could be 1 and 2.

OutPolarity

[in] A 32-bit integer variable which specifies the output polarity of output triggers.

The value should be 0 or 1.

4.2.12 GiE62_SetTriggerInPolarity

Description

Set the input polarity of output triggers.

Syntax

```
int GiE62_SetTriggerInPolarity(int CardID, int  
port, int InPolarity);
```

Parameters

CardID

[in] Card ID of GiE62. The card ID could be 0, 1, 2 and 3. It is defined by the DIP switch on GiE62.

port

[in] Port number of GiE62. The port number could be 1 and 2.

InPolarity

[in] A 32-bit integer variable which specifies the input polarity of output triggers.

The value should be 0 or 1.

4.2.13 GiE62_GetTriggerDelayTime

Description

Get the delay time of output triggers.

Syntax

```
int GiE62_GetTriggerDelayTime(int CardID, int port,  
int *DelayTime);
```

Parameters

CardID

[in] Card ID of GiE62. The card ID could be 0, 1, 2 and 3. It is defined by the DIP switch on GiE62.

port

[in] Port number of GiE62. The port number could be 1 and 2.

DelayTime

[out] Pointer to a 32-bit integer variable which stores the read out delay time of output triggers.

4.2.14 GiE62_GetTriggerOutWidth

Description

Obtain the width of output triggers.

Syntax

```
int GiE62_GetTriggerOutWidth(int CardID, int port,  
int *width);
```

Parameters

CardID

[in] Card ID of GiE62. The card ID could be 0, 1, 2 and 3. It is defined by the DIP switch on GiE62.

port

[in] Port number of GiE62. The port number could be 1 and 2.

width

[out] Pointer to a 32-bit integer variable which stores the read out width of output triggers.

4.2.15 GiE62_GetTriggerOutPolarity

Description

Get the output polarity of output triggers.

Syntax

```
int GiE62_GetTriggerOutPolarity(int CardID, int  
port, int *OutPolarity);
```

Parameters

CardID

[in] Card ID of GiE62. The card ID could be 0, 1, 2 and 3. It is defined by the DIP switch on GiE62.

port

[in] Port number of GiE62. The port number could be 1 and 2.

polarity

[out] Pointer to a 32-bit integer variable which stores the read out output polarity of output triggers.

4.2.16 GiE62_GetTriggerInPolarity

Description

Get the input polarity of output triggers.

Syntax

```
int GiE62_GetTriggerInPolarity(int CardID, int  
port, int *InPolarity);
```

Parameters

CardID

[in] Card ID of GiE62. The card ID could be 0, 1, 2 and 3. It is defined by the DIP switch on GiE62.

port

[in] Port number of GiE62. The port number could be 1 and 2.

InPolarity

[out] Pointer to a 32-bit integer variable which stores the read out input polarity of output triggers.

4.3 Error Codes

Error Code	Meaning
0	ERROR_NoError
-1	ERROR_Invalid_CardID
-2	ERROR_Invalid_PortNo
-3	ERROR_DeviceNotOpened
-4	ERROR_DeviceAlreadyOpened
-5	ERROR_ParameterExceedLimit
-6	ERROR_DeviceCannotAccess

Table 4-1: Error Codes